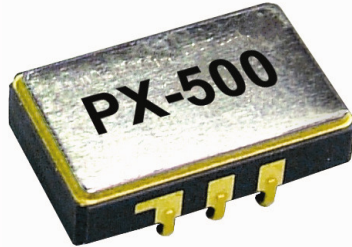

Helping Customers Innovate, Improve & Grow

PX-500
Features

- Frequency: 1 to 800 MHz
- 9x14 J-Leaded Surface Mount Package
- Surface Mount, Low Profile
- Fully RoHS Compliant *
- No Pure Tin is used in this product
- High Shock Survival up to 20Kg
- Previous Model: C1300; 042; 342
- Available as QPL MIL-PRF-55310/27, /28, or /30
- Made in USA

Applications

- Low Voltage Clock Applications
- Military Portable Radios
- Avionics and Instrumentation
- Test and Measurement Equipment
- Medical Equipment
- Navigation



* (Except parts with Sn-Pb Solder Coated Option)

Performance Specifications

Parameter	Min	Typ	Max	Units	Condition
Frequency Stabilities¹					
vs. operating temperature range (referenced to +25°C)	-15		+15	ppm	0... +70°C
	-25		+25	ppm	
	-50		+50	ppm	
	-100		+100	ppm	
	-25		+25	ppm	
-50		+50	ppm		
-100		+100	ppm		
	-50		+50	ppm	-55... +85°C
	-100		+100	ppm	
	-50		+50	ppm	-55... +105°C
	-100		+100	ppm	
	-50		+50	ppm	-55... +125°C
	-100		+100	ppm	
Initial tolerance	-15		+15	ppm	@+25°C
	-25		+25	ppm	
	-50		+50	ppm	
	-100		+100	ppm	

Performance Specifications

Parameter	Min	Typ	Max	Units	Condition
Overall tolerance (Referenced to +25°C) (includes operating temperature and initial accuracy)	-20		+20	ppm	0... +70°C
	-25		+25	ppm	
	-50		+50	ppm	
	-100		+100	ppm	
	-25		+25	ppm	
	-50		+50	ppm	-40... +85°C
	-100		+100	ppm	
	-50		+50	ppm	-55... +85°C
	-65		+65	ppm	
	-100		+100	ppm	
	-50		+50	ppm	
	-65		+65	ppm	
	-100		+100	ppm	-55... +105°C
	-65		+65	ppm	-55... +125°C
	-80		+80	ppm	
	-100		+100	ppm	
	-2		+2	ppm	
vs. supply voltage change	-1		+1	ppm	
vs. load change	-3		+3	ppm	
vs. aging / 1st year	-1		+1	ppm	
vs. aging / year (following years)					

Supply Voltage (Vs)

Supply voltage	4.75	5.0	5.25	VDC	
Supply voltage	3.135	3.3	3.465	VDC	
Supply voltage	2.375	2.5	2.625	VDC	
Current consumption (+5 VDC)			15 20 40	mA mA mA	ACMOS or TTL 1.0 to 23.9 MHz ACMOS or TTL 24 to 49.9 MHz ACMOS or TTL 50 to 125.00 MHz
Current consumption (+3.3 VDC or +2.5 VDC)			6 8 12 16 40 75 100	mA mA mA mA mA mA mA	ACMOS 1.0 to 14.9 MHz ACMOS 15.0 to 39.9 MHz ACMOS 40.0 to 59.9 MHz ACMOS 60.0 to 84.9 MHz ACMOS 85.0 to 125.0 MHz LVPECL or LVDS No load <200 MHz LVPECL or LVDS No load >200 MHz

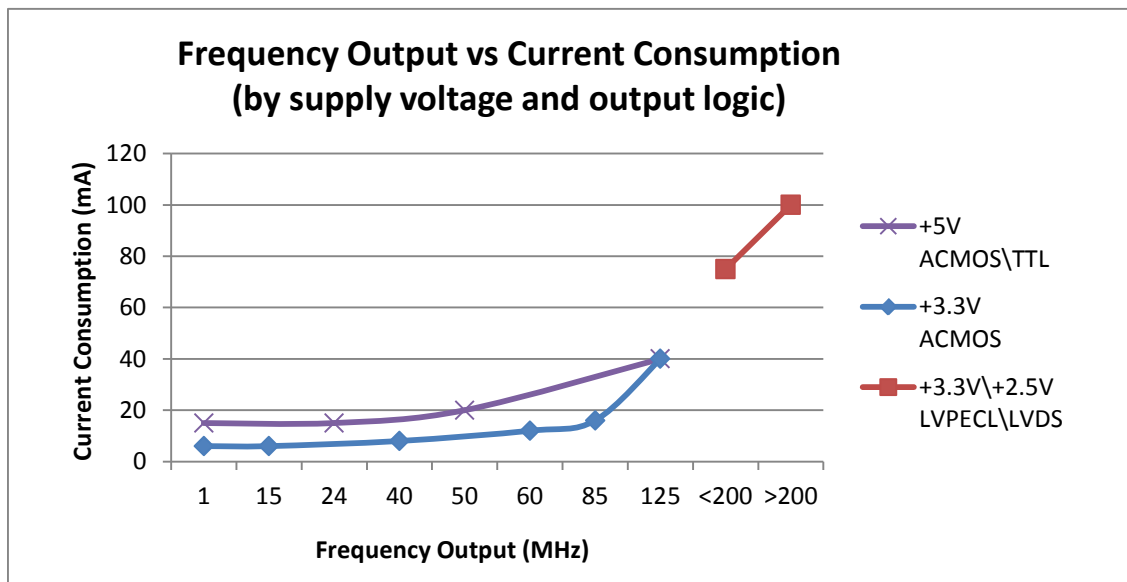

Performance Specifications

Parameter	Min	Typ	Max	Units	Condition
RF Output					
Signal	ACMOS				
Load		15		pF	
Signal Level (Vol)			0.5 0.3 0.25	VDC VDC VDC	with Vs=5.0V and 15pF load with Vs=3.3V and 15pF load with Vs= 2.5V and 15pF load
Signal Level (Voh)	4.5 3.0 2.25			VDC VDC VDC	with Vs=5.0V and 15pF load with Vs=3.3V and 15pF load with Vs=2.5V and 15pF load
Rise and fall times for ACMOS (measured 10% to 90%)			10 6 3	ns ns ns	1.0 to 23.9 MHz and 15pF load 24.0 to 79.9 MHz and 15pF load 80.0 to 125.0 MHz and 15pF load
Duty cycle	45 40		55 60	% %	@ 50% < 15 MHz @ 50% => 15 MHz
Signal	TTL				
Load			10	TTL	
Signal Level (Vol)			0.5	VDC	with Vs=5.0V and 10 TTL load
Signal Level (Voh)	2.4			VDC	with Vs=5.0V and 10 TTL load
Rise and fall times for ACMOS (measured 0.8V to 2.0V)			5 3	ns ns	1.0 to 23.9 MHz 24.0 to 125 MHz
Duty cycle	45 40		55 60	% %	@ 1.4V < 15 MHz @ 1.4V >= 15 MHz
Signal	LVPECL				
Load			50	ohm	into Vcc-2V or There in Equivalent
Signal Level (Vol)			Vs -1.62	VDC	-40....+85°C operating temp
Signal Level (Voh)	Vs- 1.025			VDC	-40....+85°C operating temp
Rise and fall times for ACMOS (measured 20% to 80%)			1000 600	ps ps	< 100 MHz >= 100 MHz
Duty cycle	45		55	%	@ 50% Vdd
Jitter (rms)			10 0.5	ps ps	BW = 10Hz to 20 MHz BW = 12KHz to 20 MHz
Period Jitter (pk-pk)			40	ps	10,000 Samples - Rising edge
Signal	LVDS				
Load	60	100	140	ohm	Between outputs
Signal Level (Vol)		1.2		VDC	
Signal Level (Voh)		1.4		VDC	
Differential Voltage (Vod)	240	330	460	mVpeak	
Common Mode (Offset) Voltage (Vos)	1.125	1.2	1.375	V	
Start-up Time			10	ms	
Rise \ Fall Time		600	1000	ps	measured @ 20% to 80% of Vod
Duty cycle	45		55	%	@ 50% of Vod
Jitter (rms)			5 1	ps ps	BW = 10Hz to 20 MHz BW = 12KHz to 20 MHz
Period Jitter (pk-pk)			40	ps	10,000 Samples - Rising edge

Performance Specifications

Parameter	Min	Typ	Max	Units	Condition
Absolute Maximum Ratings					
Supply voltage (Vs)			7.0	V	with Vs=5.0VDC and 3.3 VDC
Operable temperature range	-55		+125	°C	
Storage temperature range	-62		+125	°C	

Additional Parameters		
Screening	Vectron Verification	
	Class B, MIL-PRF-55310	
Output Enable Hi	Logic "0" input = Outputs disabled (Tri-state) Logic "1" or floating input = Outputs enabled)	Standard CMOS, TTL and LVDS
Output Enable Lo	Logic "0" or floating input = Outputs enabled Logic "1" input = Outputs disabled (Tri-state)	Standard LVPECL
Weight	< 2 grams	

Standard Environmentals	
Vibration	MIL-STD-202, Method 204, Condition G (30 G, 10Hz-2000Hz)
Shock	MIL-STD-202, Method 213, Condition I (100 G, 6ms, Sawtooth)
Acceleration	MIL-STD-883, Method 2001, Condition A (5000 G, Y1 Plane)
Temperature Cycling	MIL-STD-883, Method 1010, Condition B
Thermal Shock	MIL-STD-202, Method 107, Condition B
Solderability	MIL-STD-202, Method 208
Leak Test (Fine and Gross)	MIL-STD-883, Method 1014, Condition A1 and C1

Recommended Reflow Profiles for Pb-Free & Sn-Pb

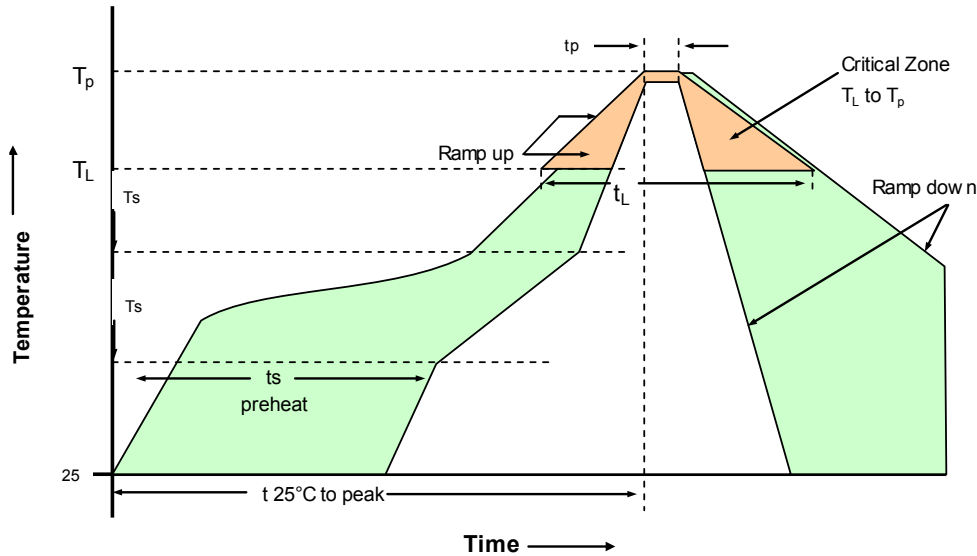

230°C Reflow Profile

Profile Feature	Sn-Pb Assembly	Profile Feature	Sn-Pb Assembly
Average ramp-up rate (TL to TP)	3°C/second max.	Time 25°C to Peak Temperature	4 minutes max.
Preheat - Temperature min Tsmin - Temperature Min Tsmax - Time (min to max) (ts)	135°C 155°C 60-90 seconds	Time maintained above - Temperature (TL) - Time (tL)	183°C 45-60 seconds
Tsmax to TL -Ramp-up Rate	3°C/seconds max.		
Time maintained above - Temperature (TL) - Time (TL)	183°C 40-60 seconds	Time within 5°C of actual Peak Temperature (tp)	10-20 seconds max.
Peak Temperature (Tp)	max 230°C	Ramp-down Rate	6°C/seconds max.

Note: All temperatures refer to topside of the package, measured on the package body surface.

260°C Reflow Profile

Profile Feature	Pb-Free Assembly	Profile Feature	Pb-Free Assembly
Average ramp-up rate (TL to TP)	3°C/second max.	Time 25°C to Peak Temperature	8 minutes max.
Preheat - Temperature min Tsmin - Temperature min Tsmax - Time (min to max) (ts)	150°C 200°C 60-180 seconds	Time maintained above - Temperature (TL) - Time (tL)	217°C 60-150 seconds
Tsmax to TL -Ramp-up Rate	3°C/second max.		
Time maintained above - Temperature (TL) - Time (TL)	217°C 60-150 seconds	Time within 5°C of actual Peak Temperature (tp)	20-40 seconds max.
Peak Temperature (Tp)	max 260°C	Ramp-down Rate	6°C/seconds max.

Note: All temperatures refer to topside of the package, measured on the package body surface.

Standard Shipping Method

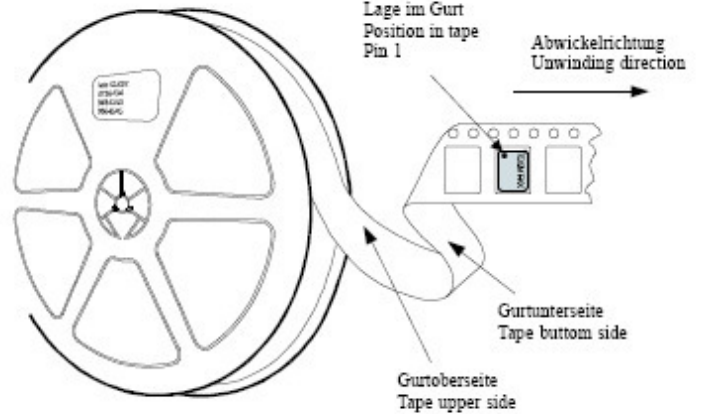
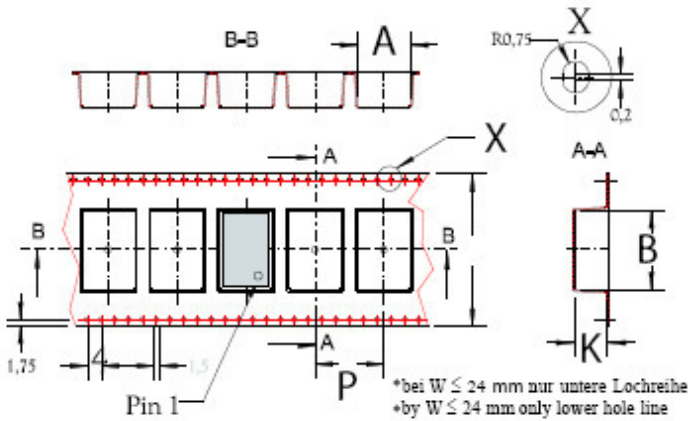

Production tolerance complying DIN IEC 286-3

Enclosure Type	Tape width W [mm]	Quantity per meter	Quantity per reel	Dimension P
9x14 mm	24 ± 0.3	44.5	1000 max	12 ± 0.1

Phase Noise and Short Term Stability Performance (Typical)

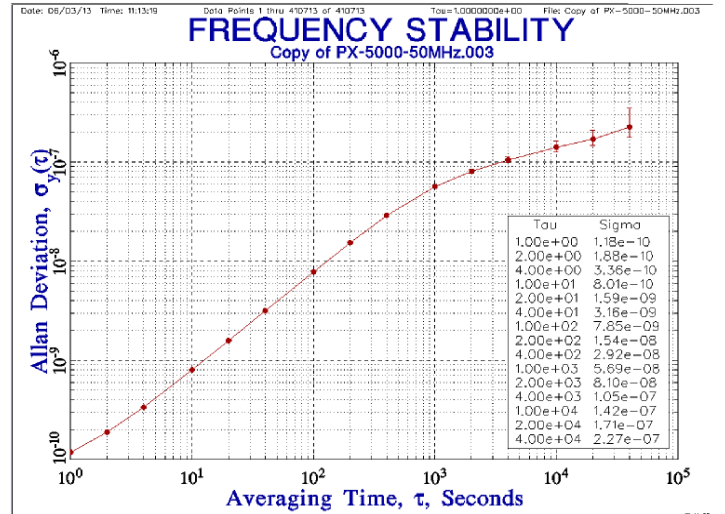
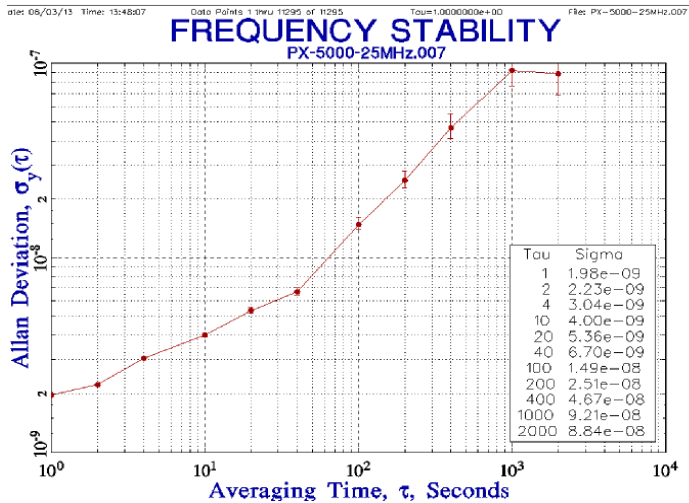
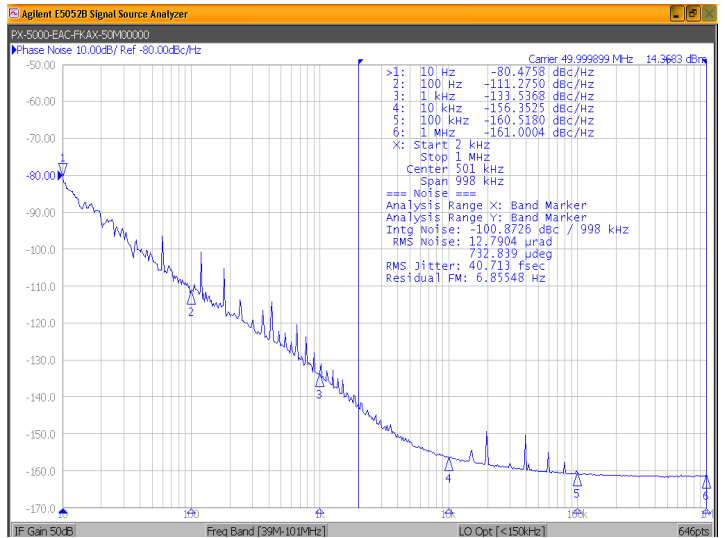
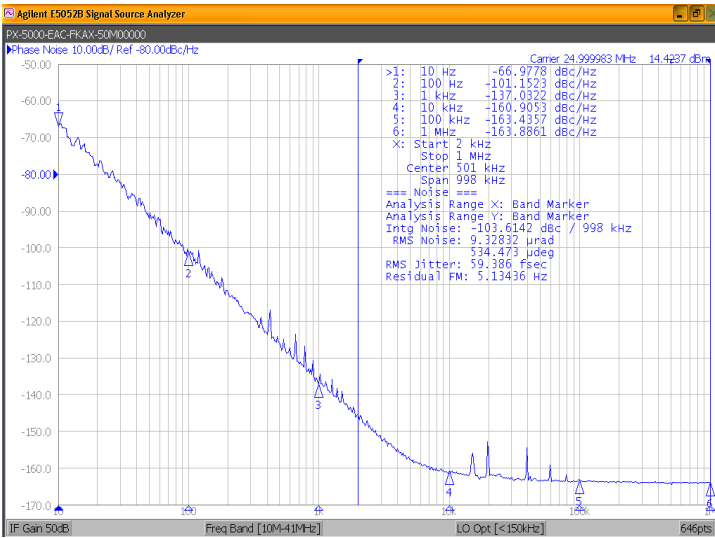

Outline Drawing / Enclosure

Type A (ACMOS or TTL)

Code	Lead Finish
0	Gold plate 30 uin min over 80 uin min nickel
2	63/37 SnPb solder coated

Pin Connections

1	Enable/Disable or N/C
2	Ground (Case)
3	RF Output
4	Supply Voltage

Type B (LVPECL or LVDS)

Code	Lead Finish
1	Gold plate 30 uin min over 80 uin min nickel
3	63/37 SnPb solder coated

Pin Connections

1	Enable/Disable or N/C
2	Enable/Disable or N/C (custom number required)
3	Ground (Case)
4	RF Output
5	Complementary Output
6	Supply Voltage

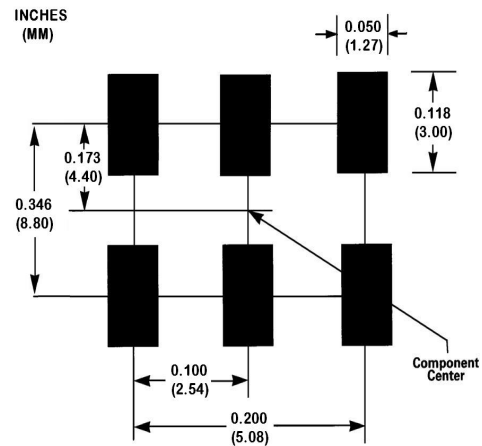
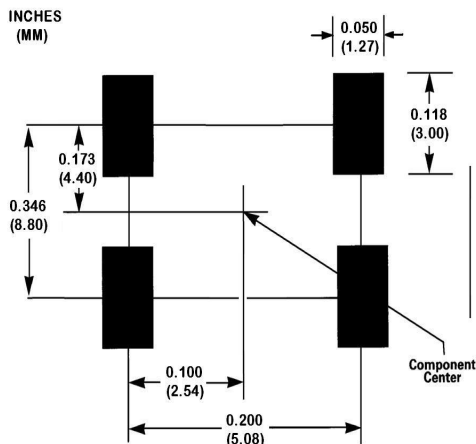
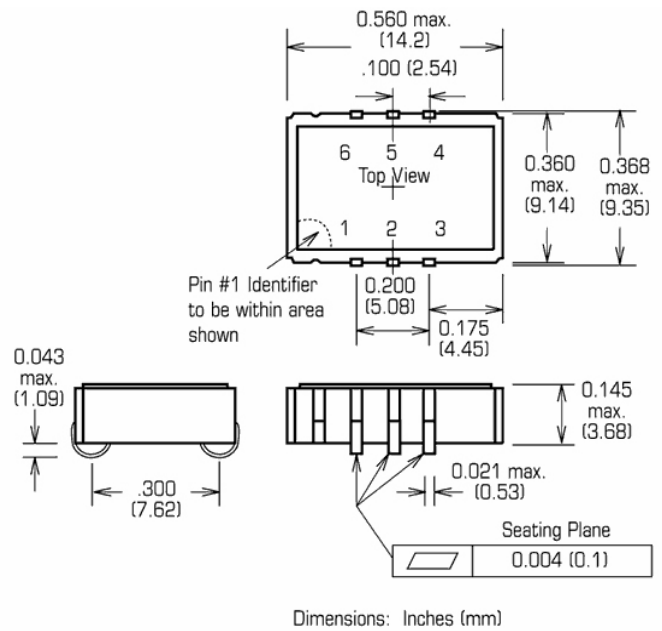
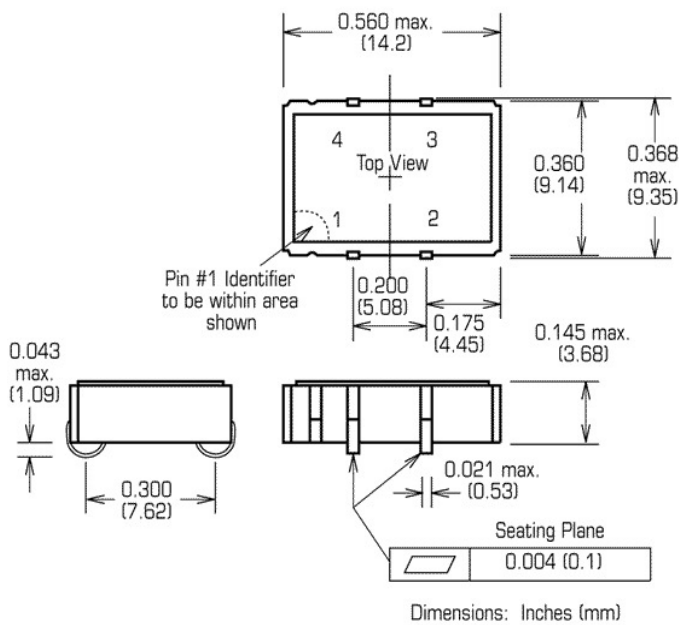

Ordering Information

PX - 500 0 - D A T - F K X B - 10M000000

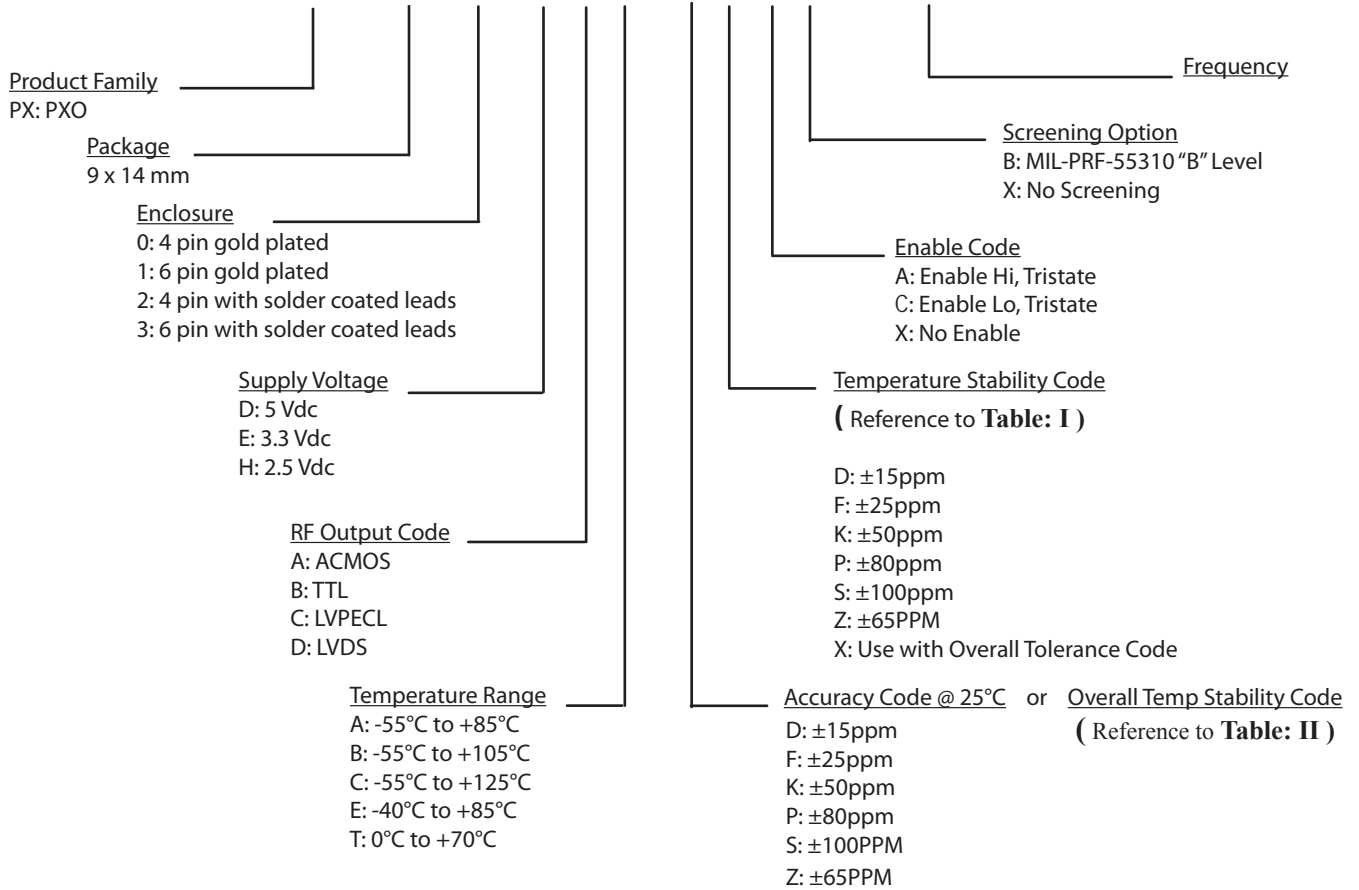

Available Temperature Stability Code	
Temp Range	Temp Stability
A: -55°C to +85°C	K: ± 50ppm
B: -55°C to +105°C	Z ± 65ppm
	P ± 80ppm
C: -55°C to +125°C	S ± 100ppm
E: -40°C to +85°C	F: ± 25ppm
	K: ± 50ppm
	Z ± 65ppm
	P ± 80ppm
T: 0°C to +70°C	S ± 100ppm
	D: ± 15ppm
	F: ± 25ppm
	K: ± 50ppm
T: 0°C to +70°C	Z ± 65ppm
	P ± 80ppm
	S ± 100ppm

Table: I

Available Overall Tolerance Code		
Temp Range	Overall Tolerance	Temp Stability
A: -55°C to +85°C	Z: ± 65ppm	X
B: -55°C to +105°C	P: ± 80ppm	X
C: -55°C to +125°C	S: ± 100ppm	X
E: -40°C to +85°C	K: ± 50ppm	X
	Z: ± 65ppm	X
	P: ± 80ppm	X
	S: ± 100ppm	X
T: 0°C to +70°C	F: ± 25ppm	X
	K: ± 50ppm	X
	Z: ± 65ppm	X
	P: ± 80ppm	X
T: 0°C to +70°C	S: ± 100ppm	X

Table: II

This Page Intentionally Left Blank

Notes:

1. Contact factory for improved stabilities or additional product options. Not all options and codes are available at all frequencies.
2. Unless other stated all values are valid after warm-up time and refer to typical conditions for supply voltage, frequency control voltage, load, temperature (25°C).
3. Subject to technical modification.
4. Contact factory for custom requirements.

For Additional Information, Please Contact

USA:

Vectron International
267 Lowell Road, Unit 102
Hudson, NH 03051
Tel: 1.888.328.7661
Fax: 1.888.329.8328

Europe:

Vectron International
Landstrasse, D-74924
Neckarbischofsheim, Germany
Tel: +49 (0) 3328.4784.17
Fax: +49 (0) 3328.4784.30

Asia:

Vectron International
68 Yin Cheng Road(C), 22nd Floor
One LuJiaZui
Pudong, Shanghai 200120, China
Tel: 86.21.6194.6886
Fax: 86.21.6194.6699

Disclaimer

Vectron International reserves the right to make changes to the product(s) and or information contained herein without notice. No liability is assumed as a result of their use or application. No rights under any patent accompany the sale of any such product(s) or information.