

Power Divider / Combiner

Model: MPD8-080180



Microot Microwave co., Ltd.

8-Way Power Divider



Features

- 1.Theoretical Insertion Loss not included in the Insertion Loss Parameter.
2. Multi-Octave bandwidth of working frequency range.
3. Superior phase balance and amplitude balance between any 2 ports.
4. Low VSWR and high Output Isolation.

Outline Drawing Unit: mm

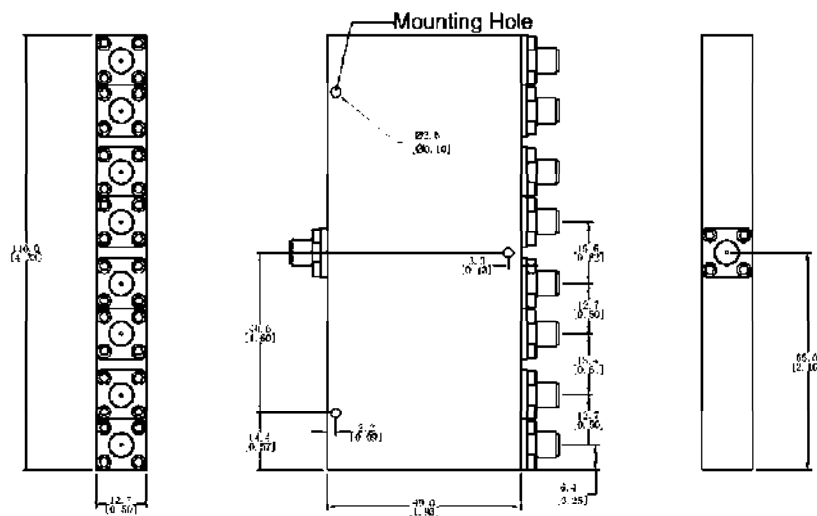

Elec. Spec. "50Ω"

[Inquiry](#)

Freq. Range (GHz)	8-18
Input VSWR Max	1.7
Output VSWR Max	1.3
Insertion Loss (dB) Max	1.3
Amp. Bal. (dB) Max	±0.8
Pha. Bal. (deg) Max	±8
Isolation (dB) Min	15
CW Power (W) Max	20
Peak Power (KW) Max	3
Connector	SMA-Female
Operating Temp. (°C)	-35~+105
Storage Temp. (°C)	-55~+125