

# Temperature Variable Chip Attenuators

## TCAF N05 Series: DC-12GHz



*Designed to vary  $-.005\text{dB/dB/}^\circ\text{C}$  to compensate for temperature induced system gain variation without requiring a bias or control voltage.*

*These surface mount attenuators consist of laser trimmed thick film resistor elements on an alumina ceramic substrate with a protective paint layer and are available in various metallization styles and plating options.*



### FEATURES

- 12GHz operation
- 2 thru 6 dB values (initially)
- Reduced attenuation at higher temperatures
- Solderable terminals
- SN62, SN96, Gold terminals available
- RoHS compliant
- Design kits available

### GENERAL SPECIFICATIONS

Resistive Element: Proprietary Thick Film  
 Substrate: Alumina  
 Terminal Finish: Electroplated Silver over Nickel  
 Temp Coefficient of Attenuation:  $-.005\text{ dB/dB/}^\circ\text{C}$   
 Temp Coefficient Tolerance:  $.001\text{ dB/dB/}^\circ\text{C}$   
 Operating Temperature Range:  $-55^\circ\text{C}$  to  $+150^\circ\text{C}$   
 Rated Power<sup>1</sup>: 2 W average

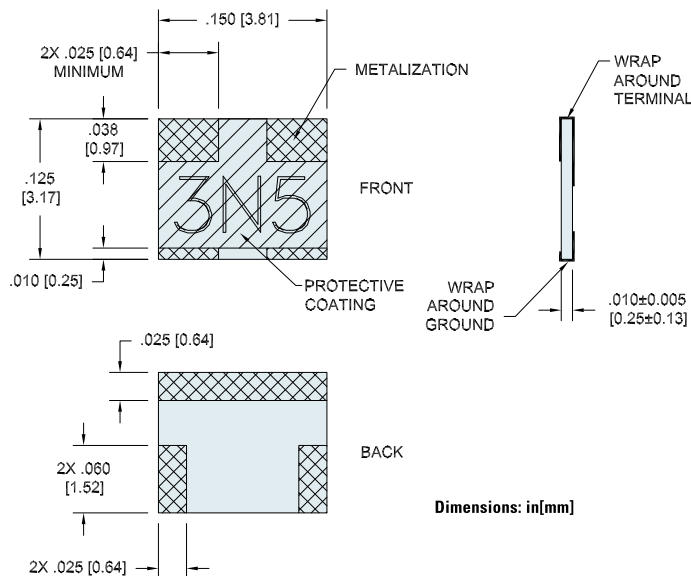

### ELECTRICAL SPECIFICATIONS

Model Number	dB Value	Attenuation Accuracy <sup>2</sup> (dB)		Max VSWR	
		DC-8GHz	8-12GHz	DC-8GHz	8-12GHz
TCAF-2-N05	2	±0.5	±0.75	1.35:1	1.50:1
TCAF-3-N05	3	±0.5	±0.75	1.35:1	1.50:1
TCAF-4-N05	4	±0.5	±0.75	1.35:1	1.50:1
TCAF-5-N05	5	±0.5	±0.75	1.35:1	1.50:1
TCAF-6-N05	6	±0.5	±0.75	1.35:1	1.50:1

<sup>1</sup>Assumes 100° C mounting temperature derated linearly to 0 Watts at 150° C <sup>2</sup>Performance is based on device mounted in matched 50Ω line.

# Temperature Variable Chip Attenuators

## TCAF N05 Series: DC-12GHz



### ATTENUATION VS. FREQUENCY

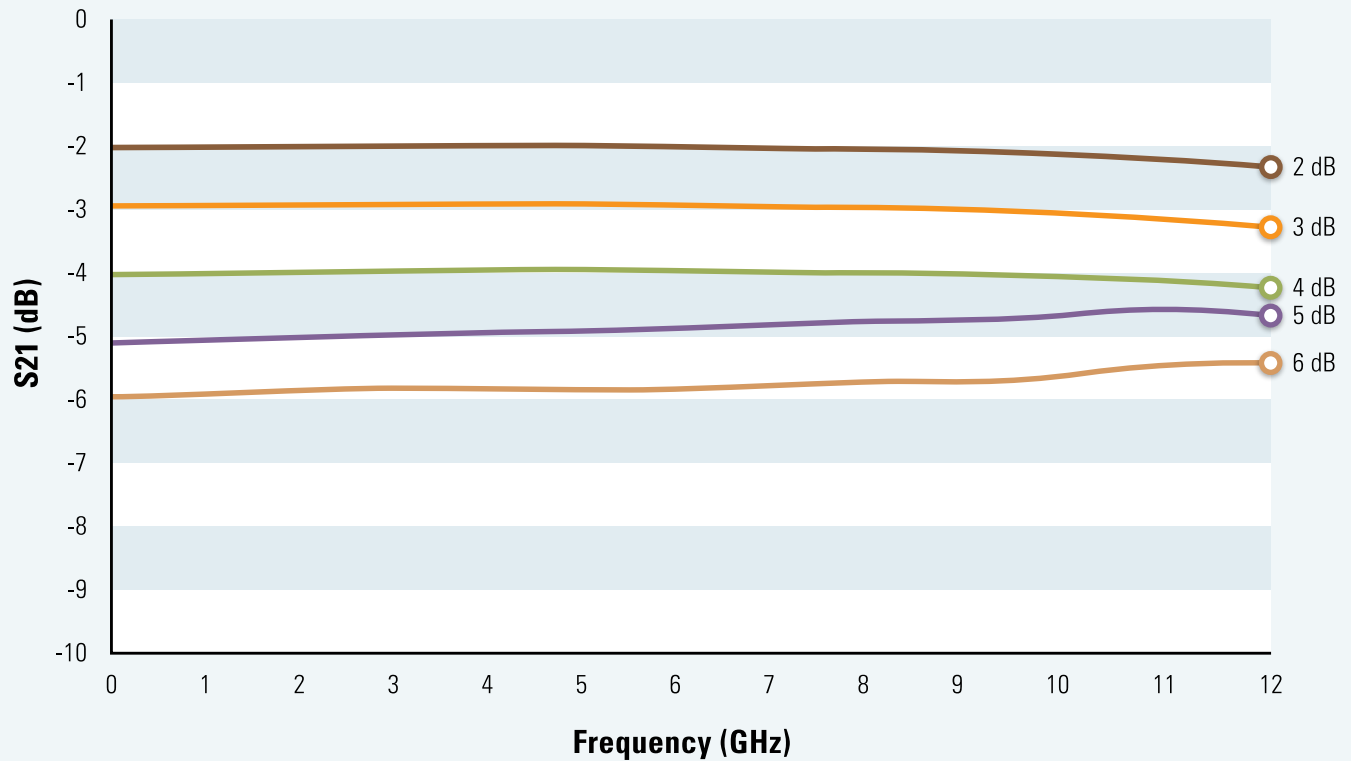

### PC BOARD LAYOUT

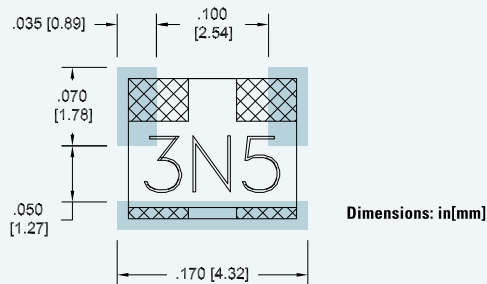

### ORDERING KEY

Model Number

**TCAF-T3-N05**

Terminal Options:  
 = Silver over Nickel [standard]  
**T** = Tin Lead Solder  
**H** = Lead Free Solder  
**G** = Gold Plated

Temp Shift: Negative

Temp Coefficient of Attenuation: .005dB/dB/°C

# Temperature Variable Chip Attenuators

## TCAF N05 Series: DC-12GHz



TCAF-2-N05 Attenuation vs. Frequency vs. Temperature

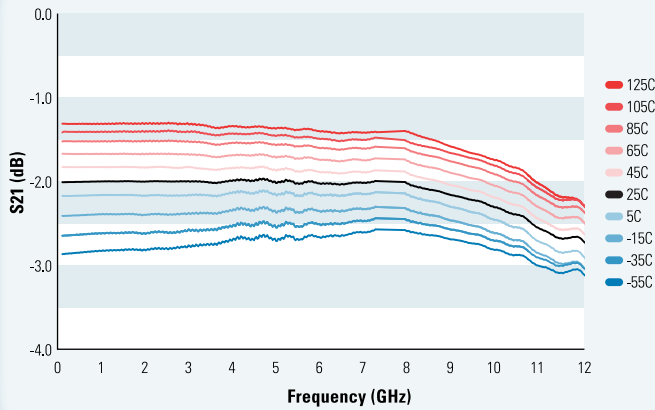

TCAF-2-N05 VSWR vs. Frequency vs. Temperature

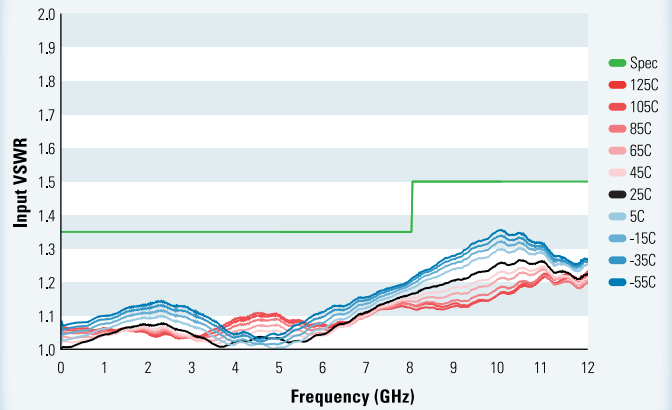

TCAF-3-N05 Attenuation vs. Frequency vs. Temperature

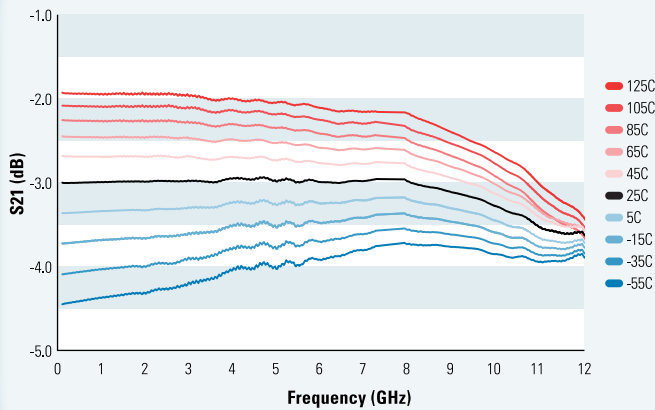

TCAF-3-N05 VSWR vs. Frequency vs. Temperature

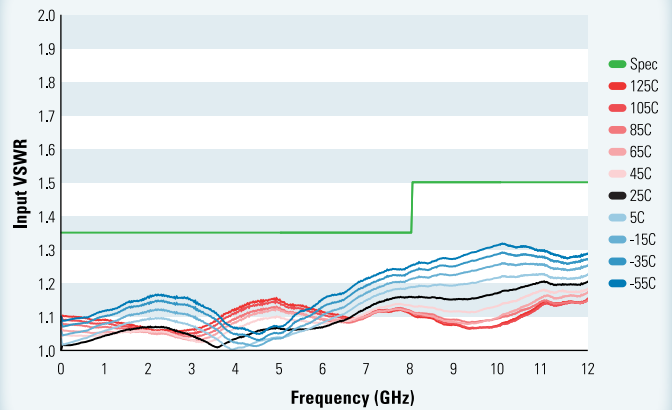

TCAF-4-N05 Attenuation vs. Frequency vs. Temperature

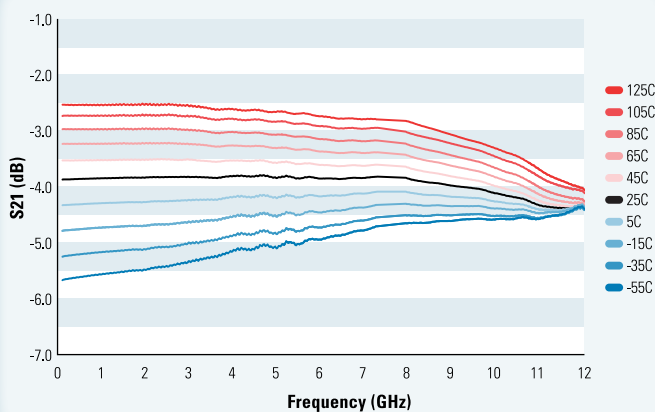

TCAF-4-N05 VSWR vs. Frequency vs. Temperature

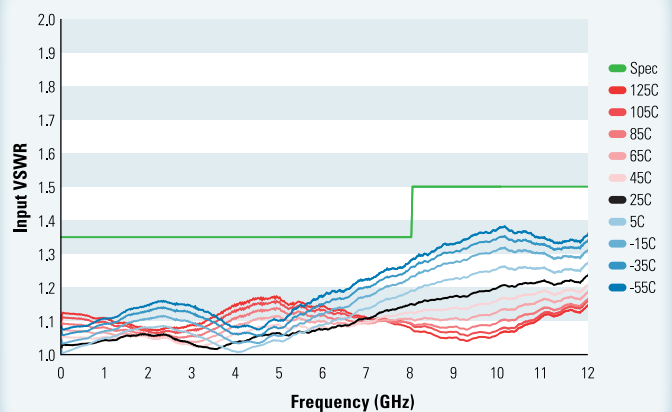

# Temperature Variable Chip Attenuators

## TCAF N05 Series: DC-12GHz



TCAF-5-N05 Attenuation vs. Frequency vs. Temperature

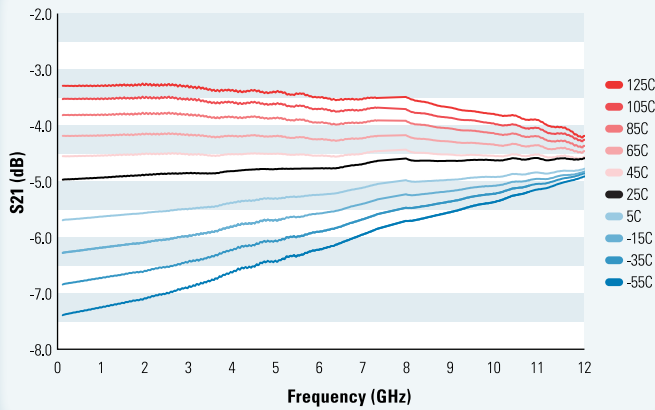

TCAF-5-N05 VSWR vs. Frequency vs. Temperature

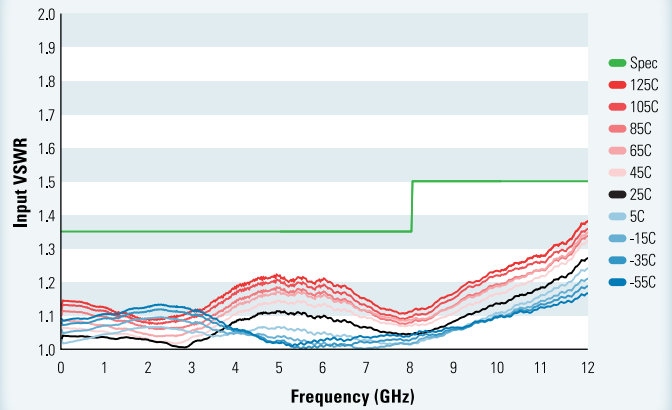

TCAF-6-N05 Attenuation vs. Frequency vs. Temperature

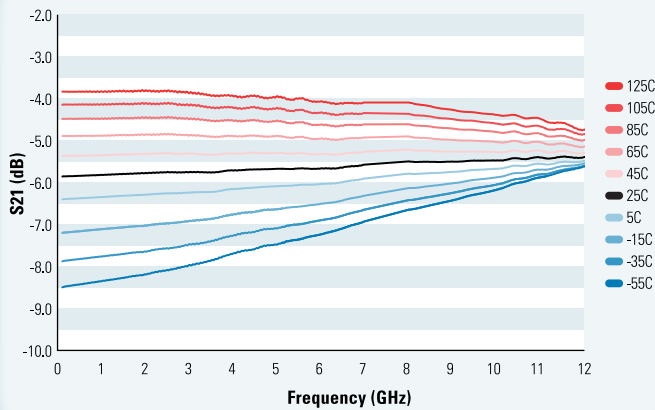

TCAF-6-N05 VSWR vs. Frequency vs. Temperature

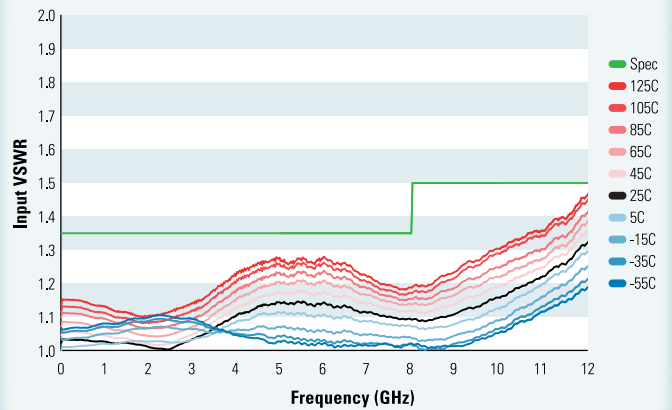

300 Dino Drive  
Ann Arbor, MI 48103-9457

[www.aeroflex.com/inmet](http://www.aeroflex.com/inmet)

1-888-244-6638 or 734-426-5553