

RFSA3043

75Ω Voltage Controlled Attenuator 5MHz to 3000MHz

RFMD's RFSA3043 is a fully monolithic analog voltage controlled attenuator (VCA) featuring exceptional linearity over a typical temperature compensated 30dB gain control range. It incorporates a revolutionary new circuit architecture to solve a long standing industry problem: high IP3, high attenuation range, low DC current, broad bandwidth and temperature compensated linear in dB control voltage characteristic. This voltage controlled attenuator is controlled by a single positive control voltage with on-chip DC conditioning circuitry. The slope of the control voltage versus gain is selectable. The RFSA3043 draws a very low 2mA current and is packaged in a small 3mm x 3mm QFN. This attenuator is matched to 75Ω over its rated control range and frequency with no external matching components required. Typical VCAs in this performance category have poor inherent attenuation versus temperature and poor nonlinear attenuation versus control voltage characteristics. To correct these short-comings, other VCAs require extensive off chip analog support circuitry that consumes valuable PCB area and additional DC power. This game changing product incorporates the complete solution in a small 3mm x 3mm QFN package that reduces the footprint 20x in area and reduces the DC power by 5x over conventional PIN diode approaches.

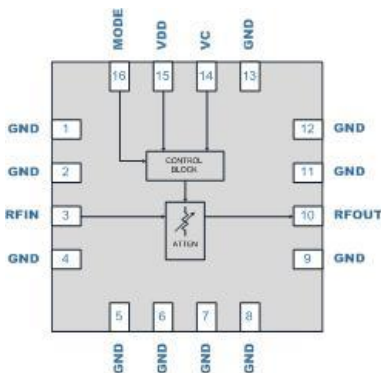

Functional Block Diagram

Ordering Information

RFSA3043SQ	Sample bag with 25 pieces
RFSA3043SR	7" Reel with 100 pieces
RFSA3043TR7	7" Reel with 2500 pieces
RFSA3043PCK-410	5MHz to 3000MHz PCBA with 5-piece sample bag



Package: QFN, 16-pin,
3.0mm x 3.0mm

Features

- Patent Pending Circuit Architecture
- Broadband 5MHz to 3000MHz Frequency Range
- 30dB Attenuation Range
- +50dBm Input IP3 Typical
- +80dBm Input IP2 Typical
- Low Distortion -80dBc CSO and -75dBc CTB for 132 Channel 38dBmV Input
- High 1dB Compression Point >+30dBm
- Low Supply Current 2mA Typical
- 3V to 5V Power Supply
- Linear in dB Control Characteristic
- Internal Temperature Compensation
- Class 2 ESD (2000V)
- Complete Solution in a Small 3mm x 3mm, QFN Package

Applications

- Cable Modems
- CATV
- High Linearity Power Control

Absolute Maximum Ratings

Parameter	Rating	Unit
Control Voltage (V_C)	-0.5 to +6	V
Supply Voltage (V_{DD})	-0.5 to +6	V
Mode Pin Voltage (MODE)	-0.5 to +6	V
RF Input Power	+30	dBm
Storage Temperature Range	-65 to +150	°C
ESD Rating - Human Body Model (HBM)	2000 (Class 2)	V
Moisture Sensitivity Level	MSL1	



Caution! ESD sensitive device.



RFMD Green: RoHS status based on EU Directive 2011/65/EU (at time of this document revision), halogen free per IEC 61249-2-21, < 1000ppm each of antimony trioxide in polymeric materials and red phosphorus as a flame retardant, and <2% antimony in solder.

Exceeding any one or a combination of the Absolute Maximum Rating conditions may cause permanent damage to the device. Extended application of Absolute Maximum Rating conditions to the device may reduce device reliability. Specified typical performance or functional operation of the device under Absolute Maximum Rating conditions is not implied.

Recommended Operating Condition

Parameter	Specification			Unit
	Min	Typ	Max	
Operating Temperature Range (RF Input Power Handling De-rates Above 85°C)	-40		+105	°C
Operating Junction Temperature			+125	°C
Supply Voltage	3	5	5.5	V

Nominal Operating Parameters

Parameter	Specification			Unit	Condition
	Min	Typ	Max		
General Performance					
Supply Current		2		mA	
Thermal Resistance		35		°C/W	RF input must be RFIN pin
RF Input Power			27	dBm	
RF Performance					
Frequency Range	5		3000	MHz	
Minimum Insertion Loss		1.5	2.5	dB	
Gain Control Range	30	35		dB	
Gain versus Temperature		1.5		dB	Peak to peak gain variation over temperature for fixed control voltage
Return Loss		15		dB	
Relative Phase		5		Deg	Insertion phase at 15dB attenuation relative to minimum attenuation
Input 1dB Compression Point		30		dBm	
Input IP3		50		dBm	$P_{IN} + (IM3_{dBc}/2)$
Input IP2		80		dBm	$P_{IN} + IM2_{dBc}$, IM2 is F1 + F2
Input IH2		85		dBm	$P_{IN} + H2_{dBc}$, H2 is second harmonic

Parameter	Specification			Unit	Condition
	Min	Typ	Max		
Input IH3		55		dBm	$P_{IN} + (H3_{dBc}/2)$, H3 is third harmonic
Composite Performance					$V_{DD} = 5V, V_C = 3.5V, Temp = +25^{\circ}C$
CSO		-80		dBc	55.25MHz to 865.25MHz, 132 channel, +38dBmV input flat tilt
CTB		-75		dBc	
XMOD		-70		dBc	
Control					
Voltage Control Range, Positive Attenuation Slope	0		5	V	5V control voltage is lowest insertion loss, MODE pin high
Voltage Control Range, Negative Attenuation Slope	0		5	V	0V control voltage is lowest insertion loss, MODE pin low
Voltage Control Pin Current (MODE High)		37		μA	VC Pin at 5V
Voltage Control Pin Current (MODE Low)		37		μA	VC Pin at 5V
MODE Pin Logic Low			0.4	V	
MODE Pin Logic High	1			V	
Settling Time		10		μSec	1dB attenuation change settling with 0.1dB

Note: Typical performance conditions unless otherwise specified: +25°C, 1000MHz, 5V supply voltage

Typical Performance: 5MHz to 1200MHz Application Circuit

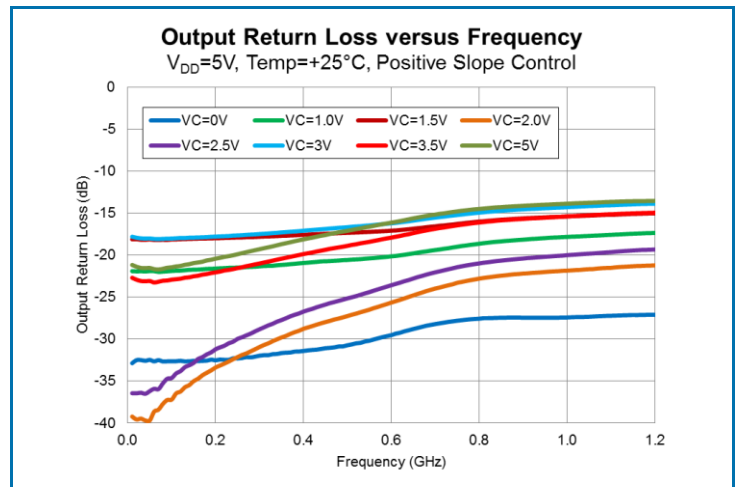
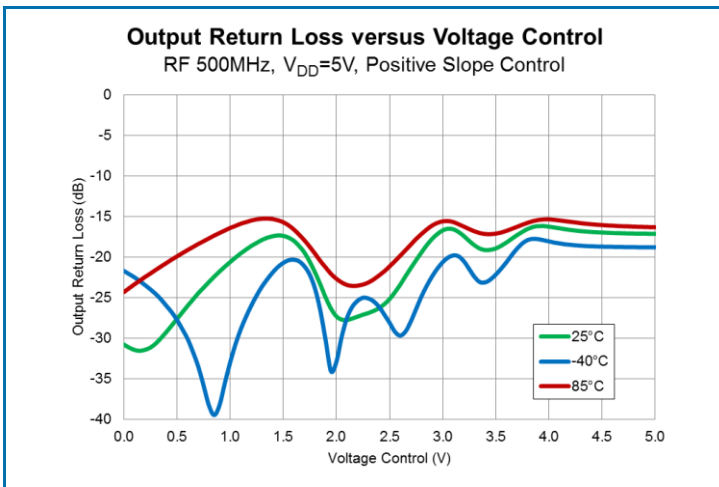
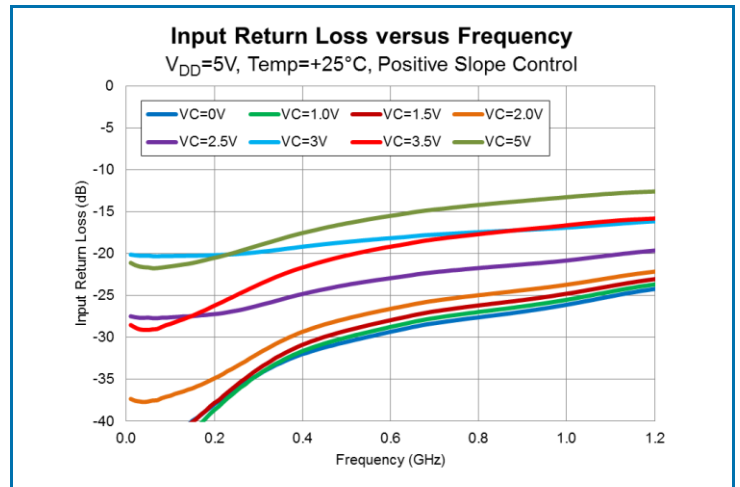
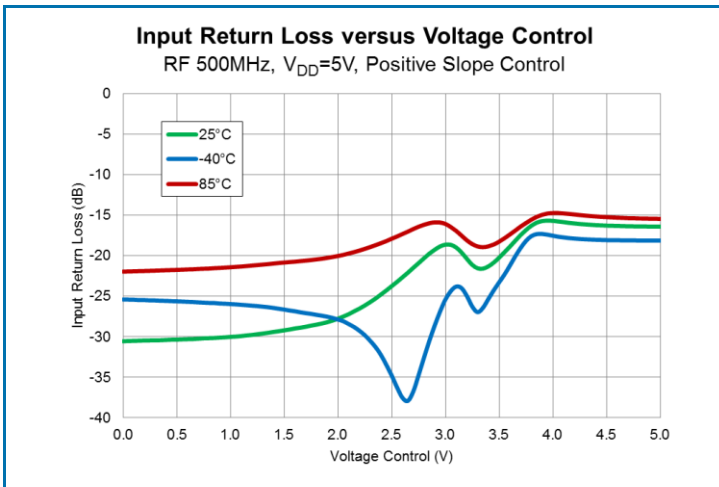
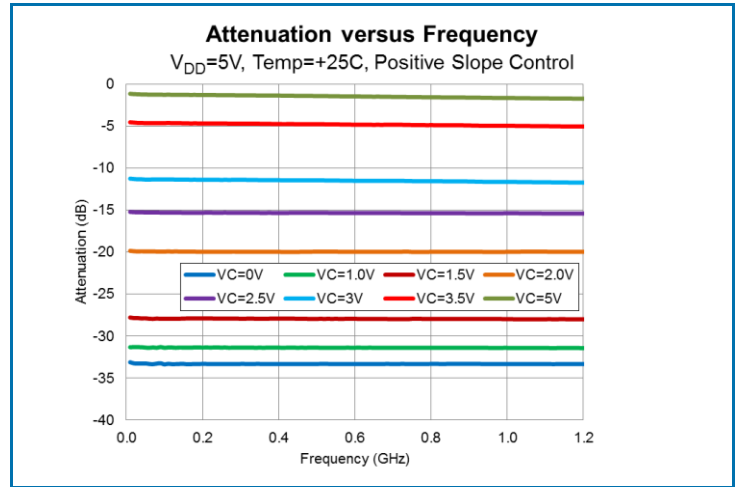
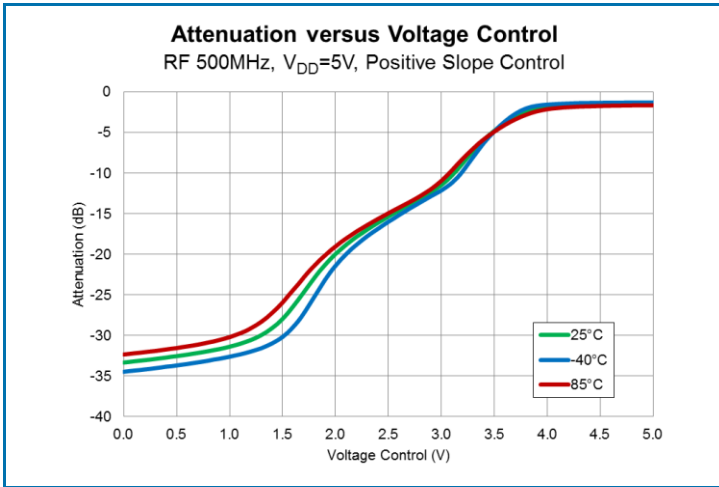

Typical Performance: 5MHz to 1200MHz Application Circuit

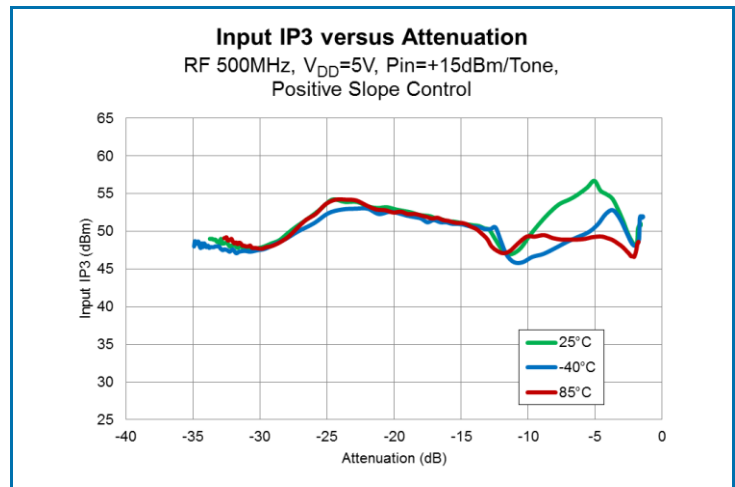
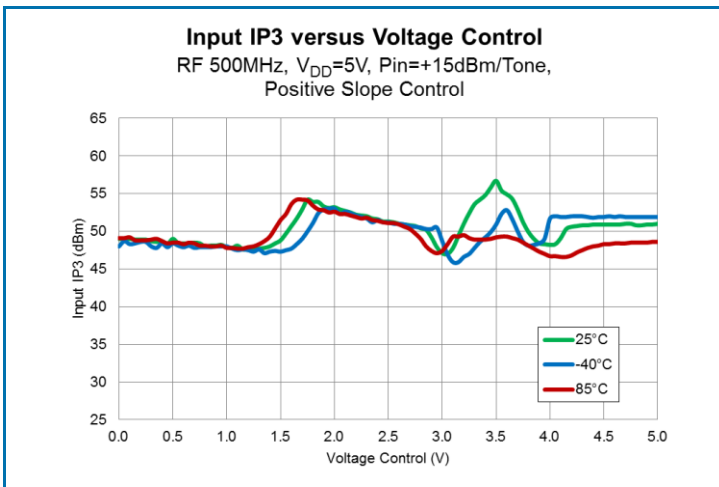
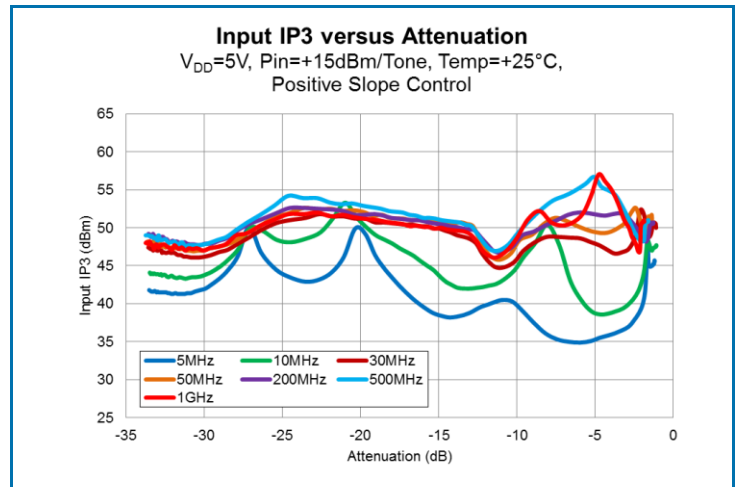
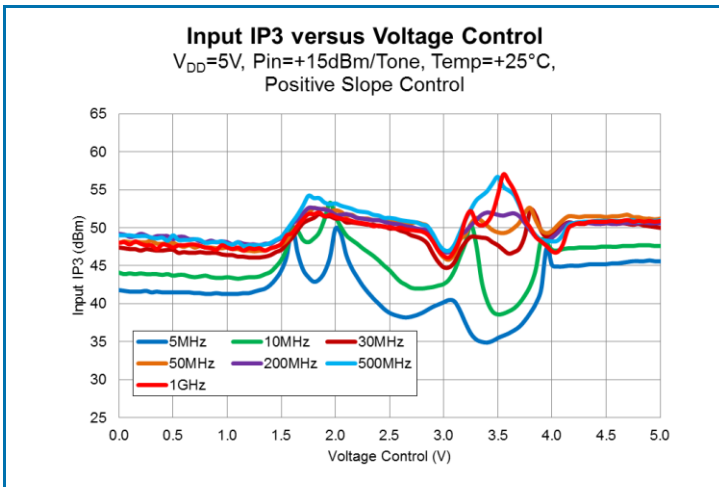
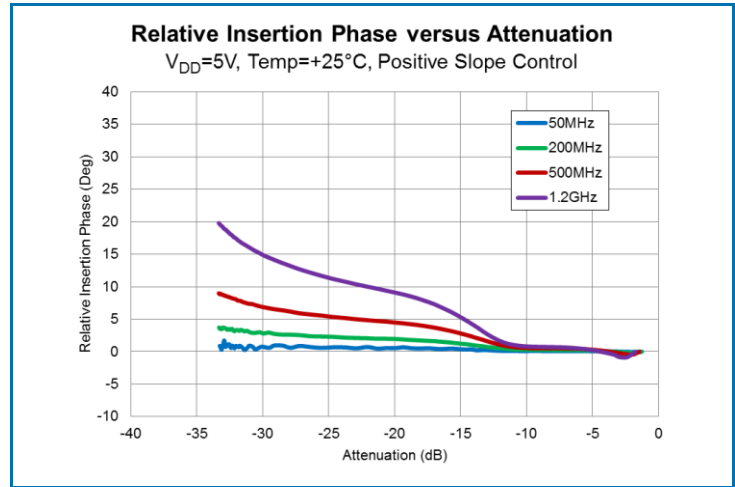
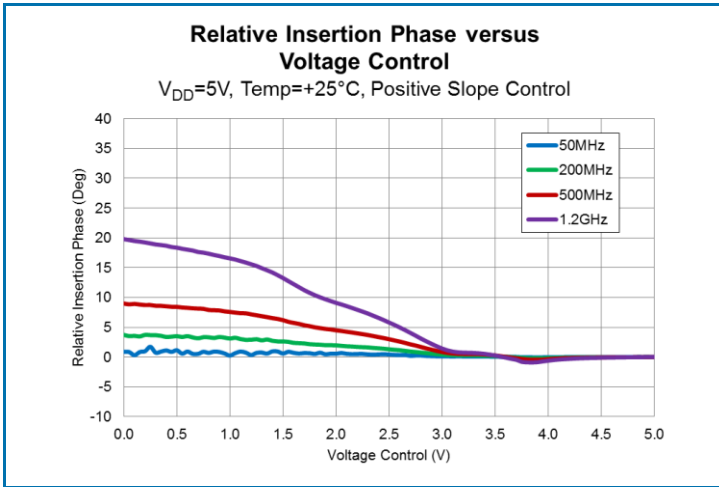

Typical Performance: 5MHz to 1200MHz Application Circuit

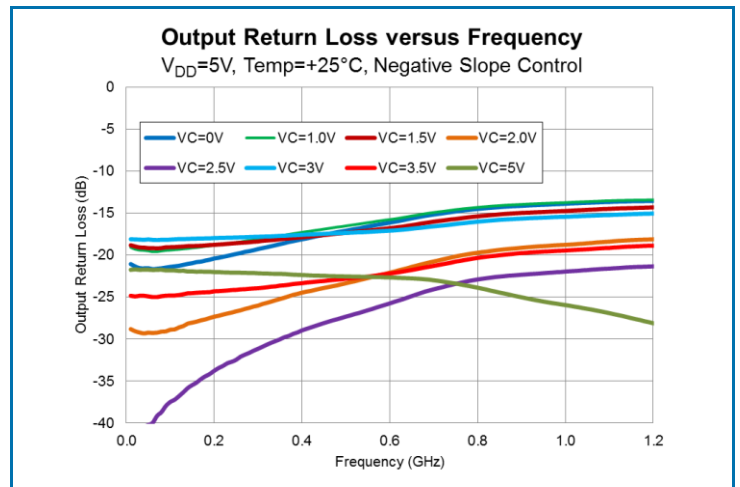
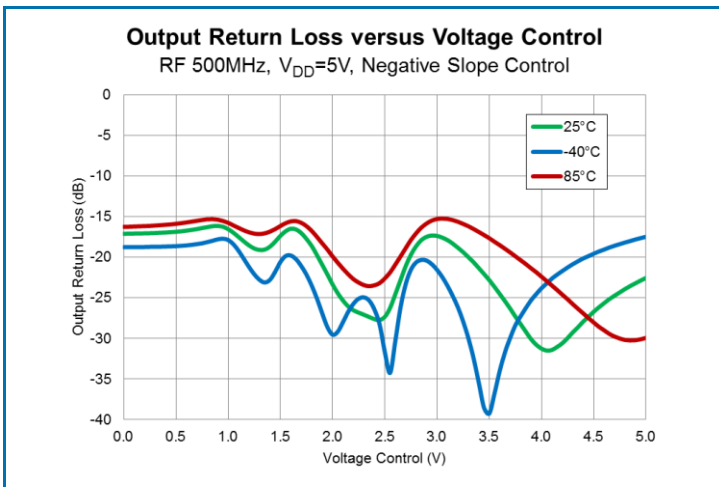
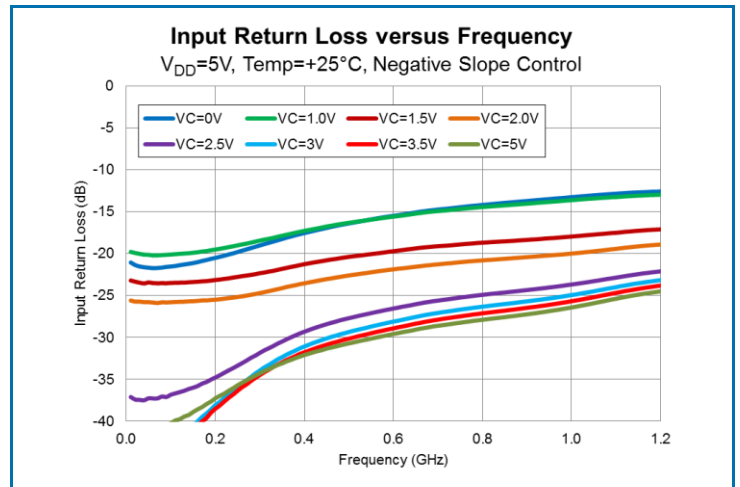
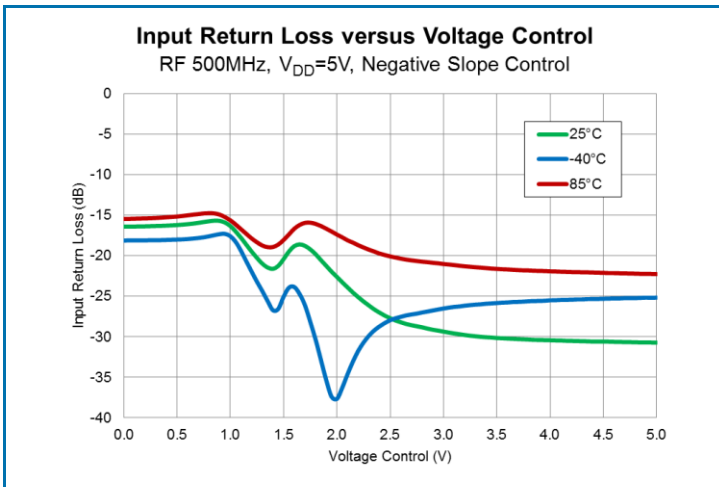
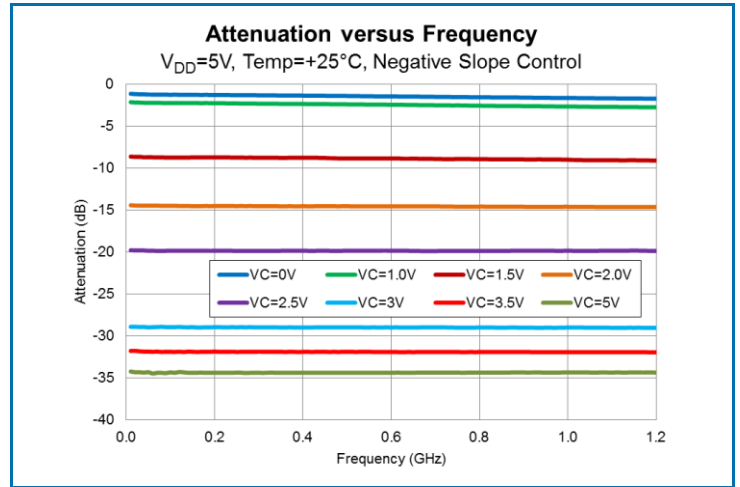
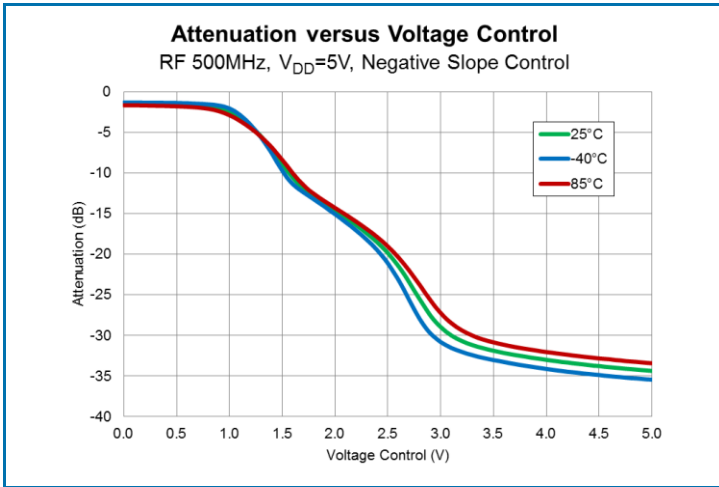

Typical Performance: 5MHz to 1200MHz Application Circuit

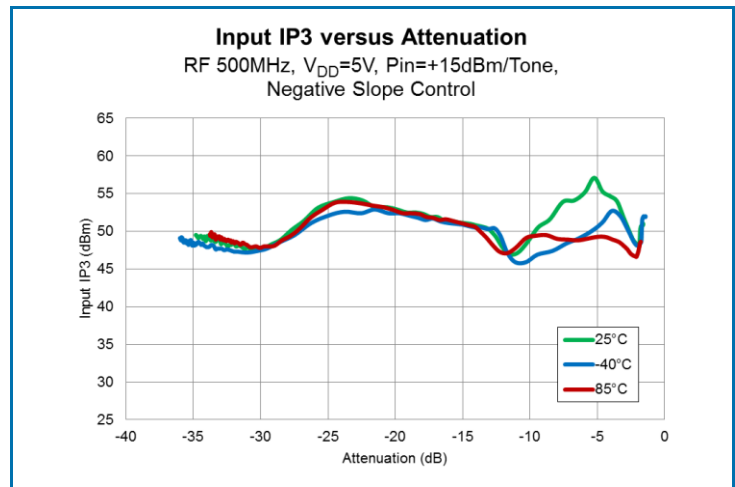
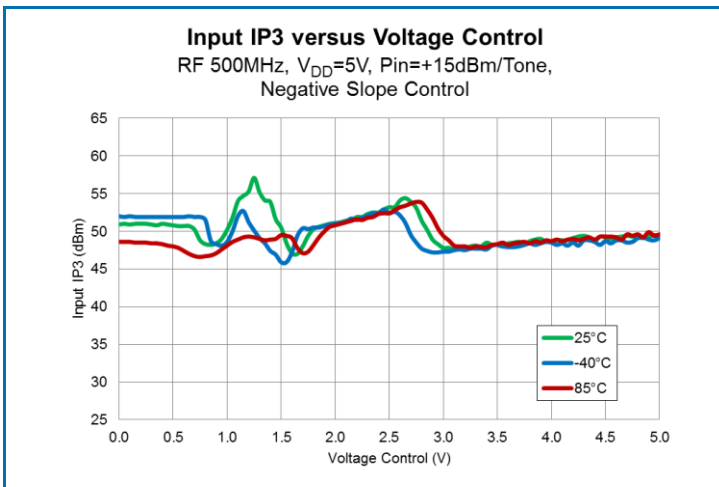
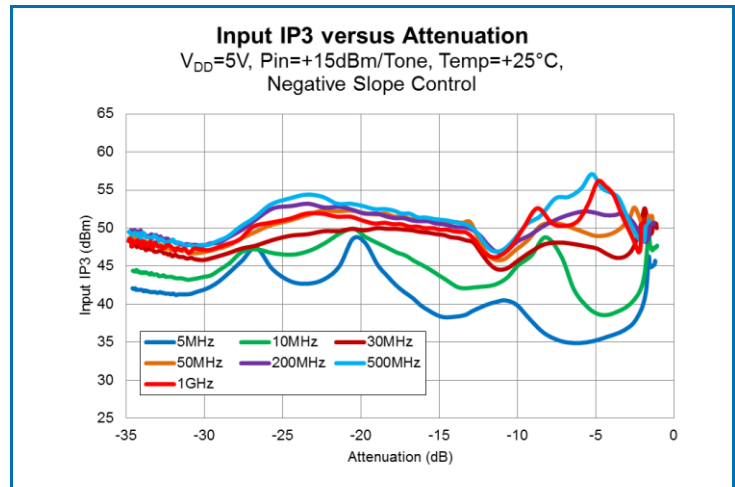
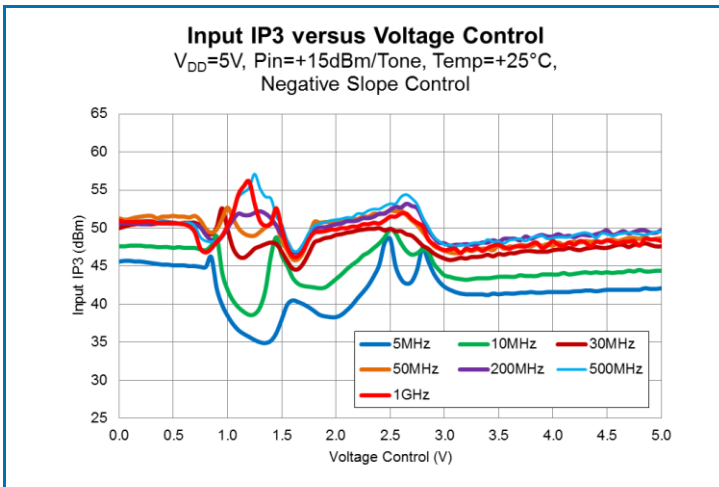
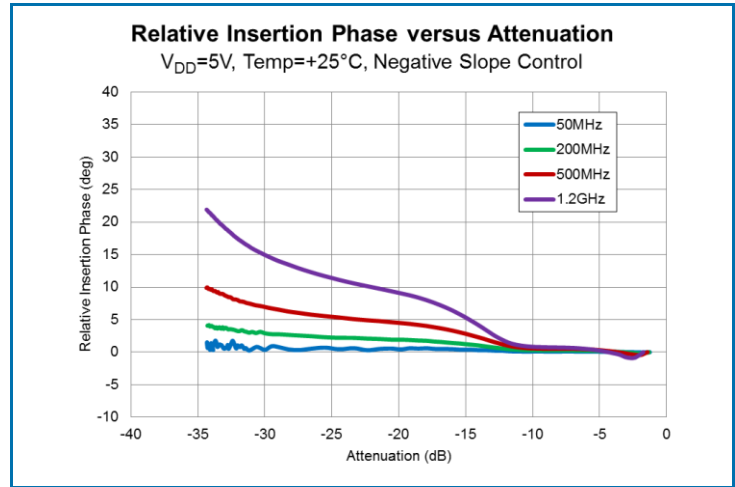
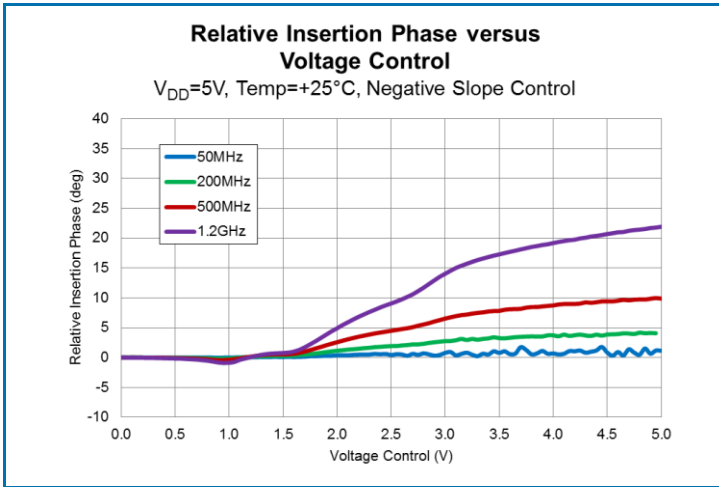

Typical Performance: 5MHz to 1200MHz Application Circuit

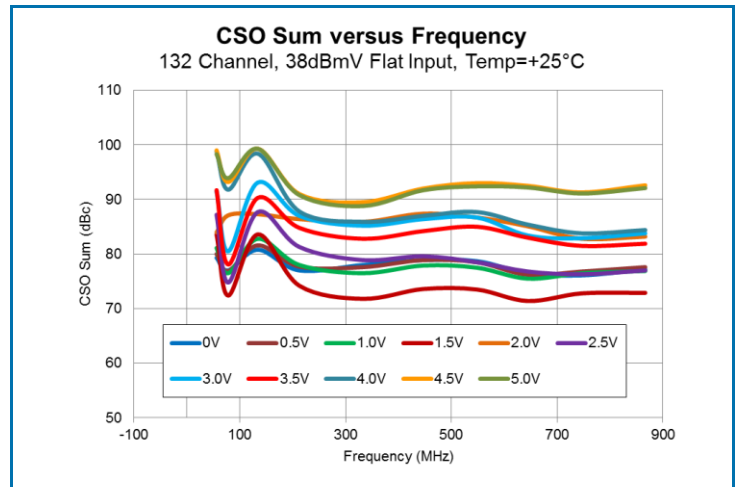
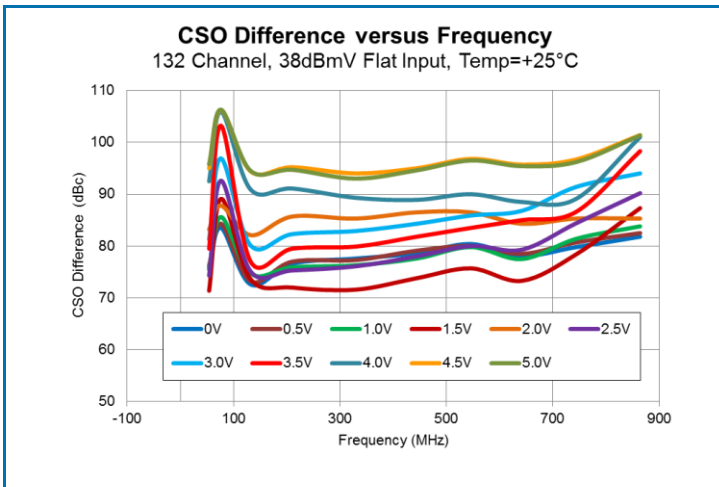
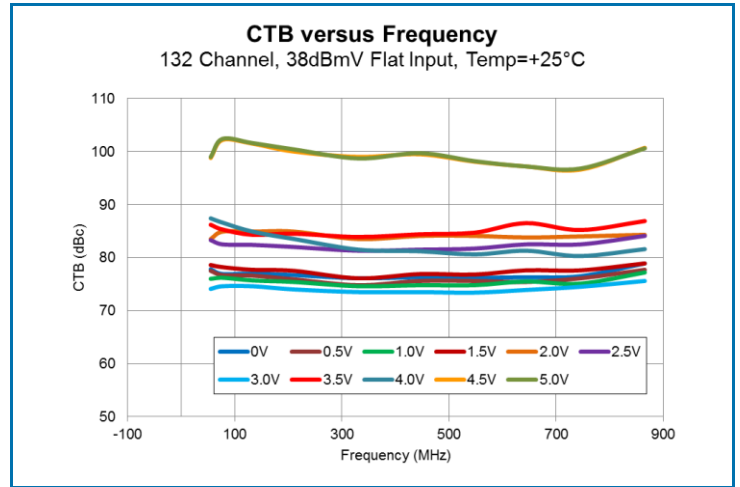
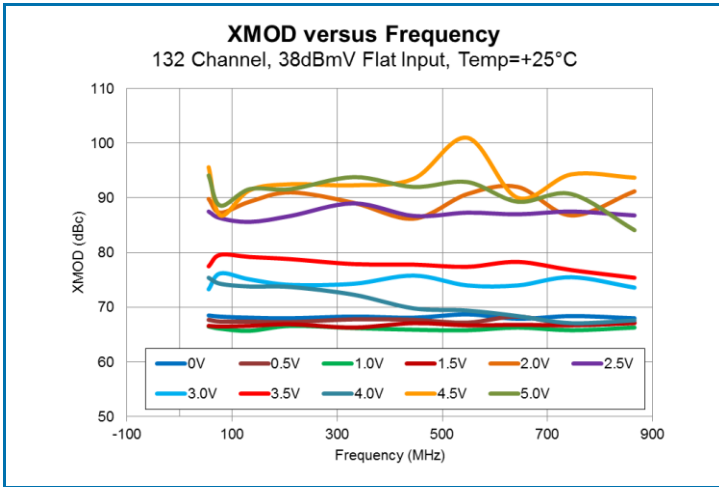

Typical Application Schematic 5MHz to 1200MHz Application Circuit

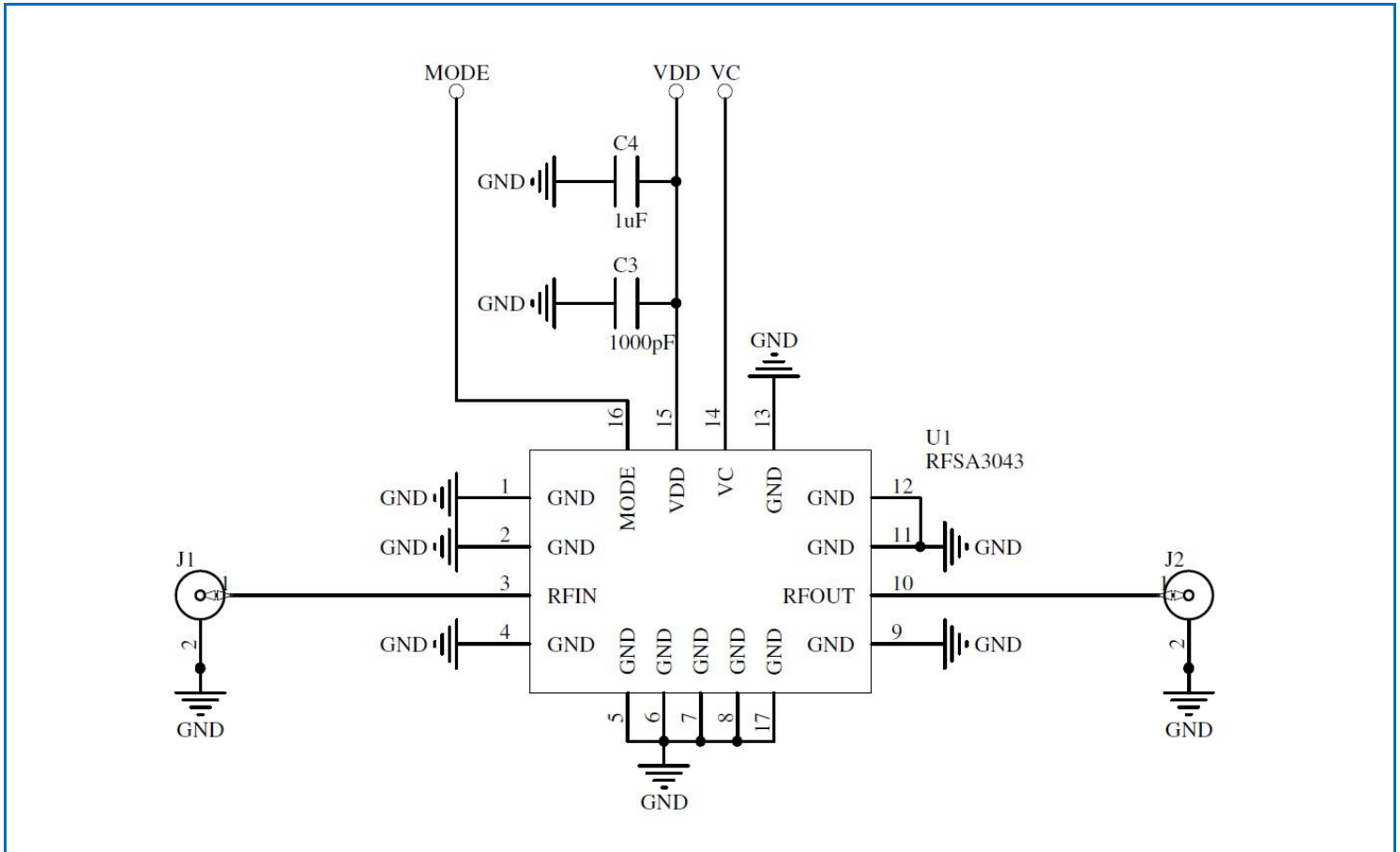

Typical Performance: 5MHz to 3000MHz Application Circuit

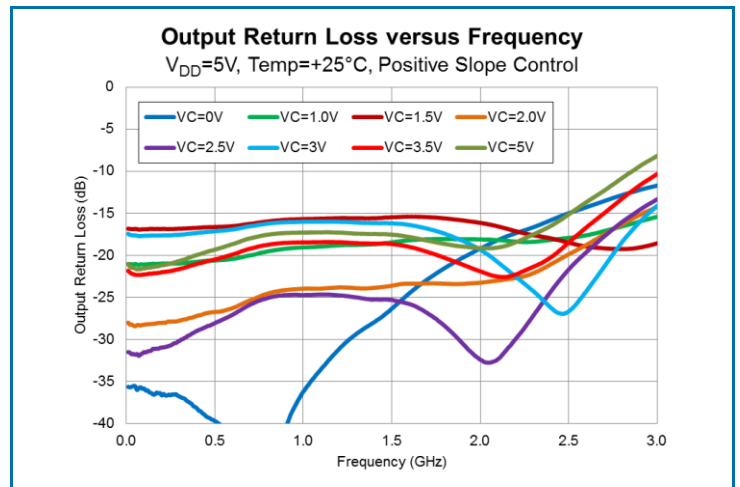
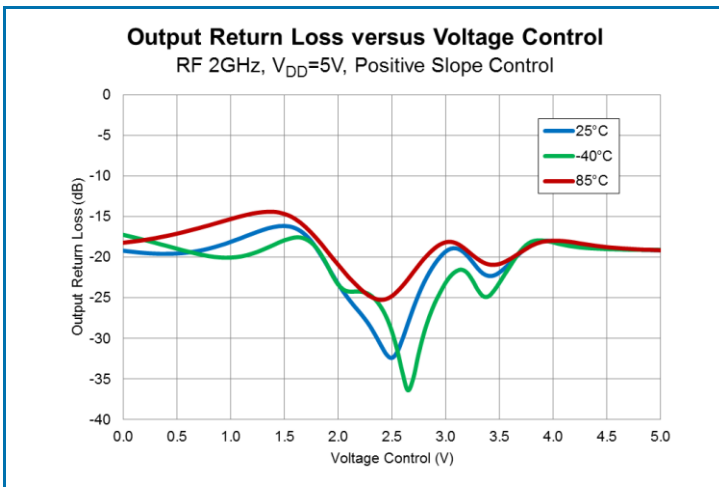
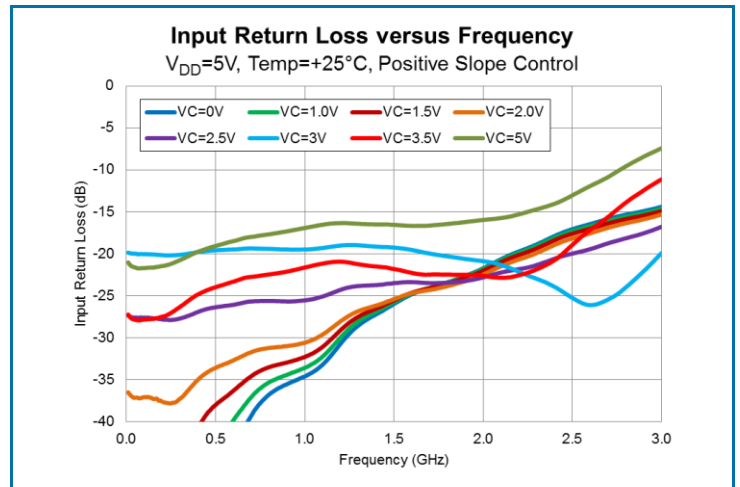
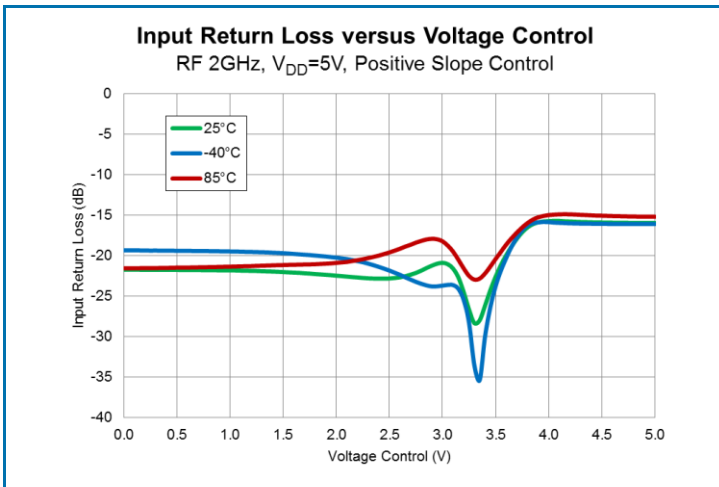
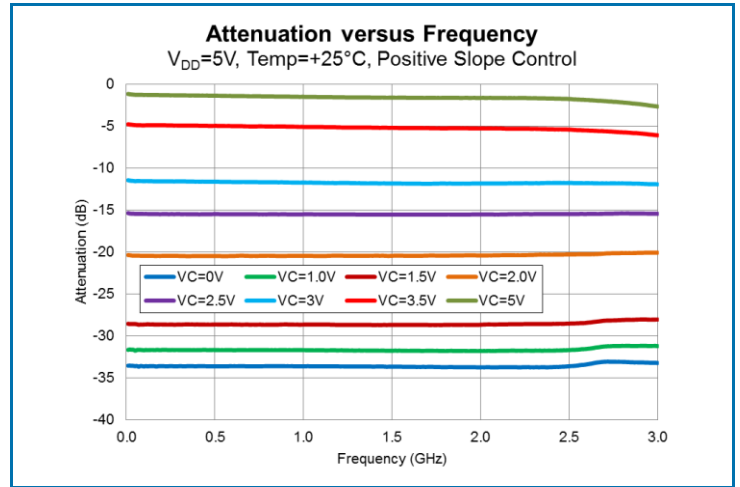
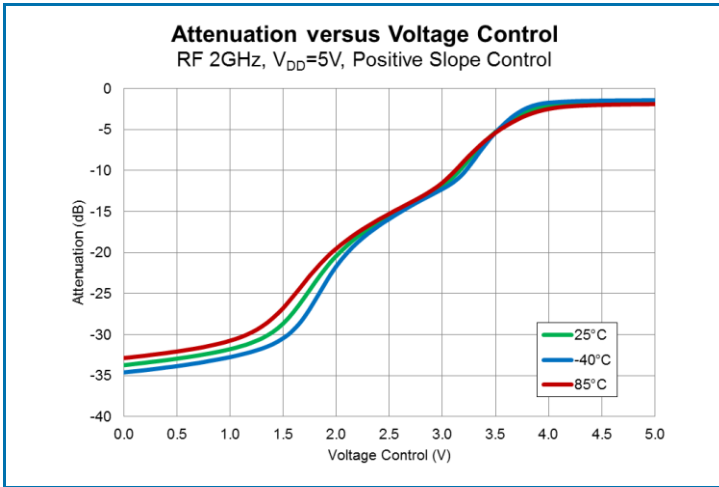

Typical Performance: 5MHz to 3000MHz Application Circuit

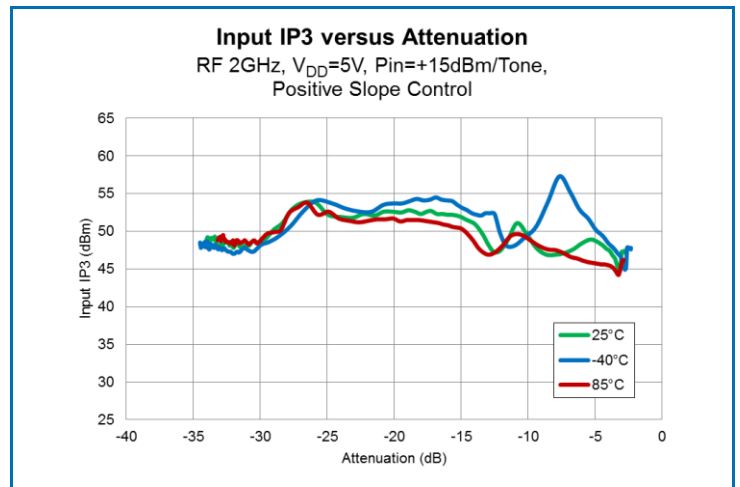
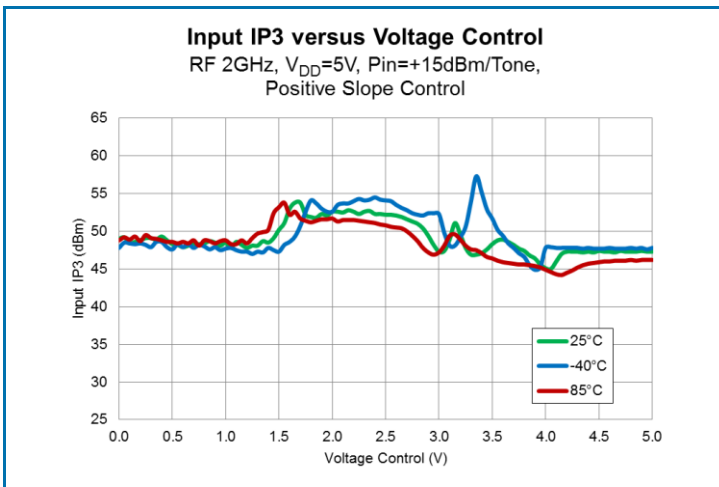
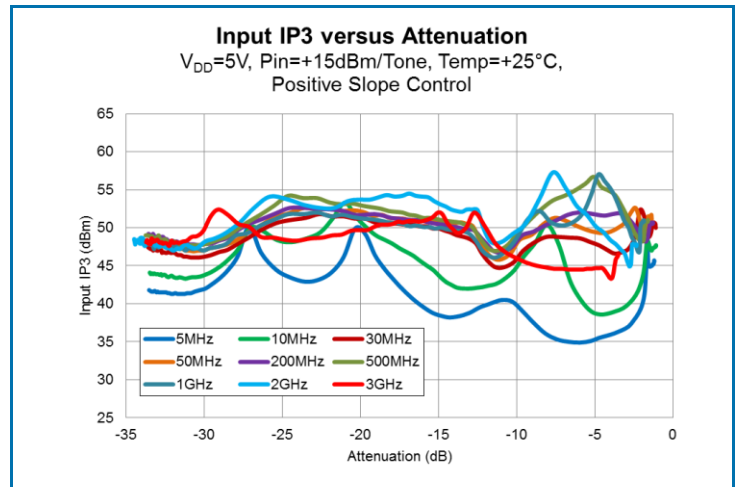
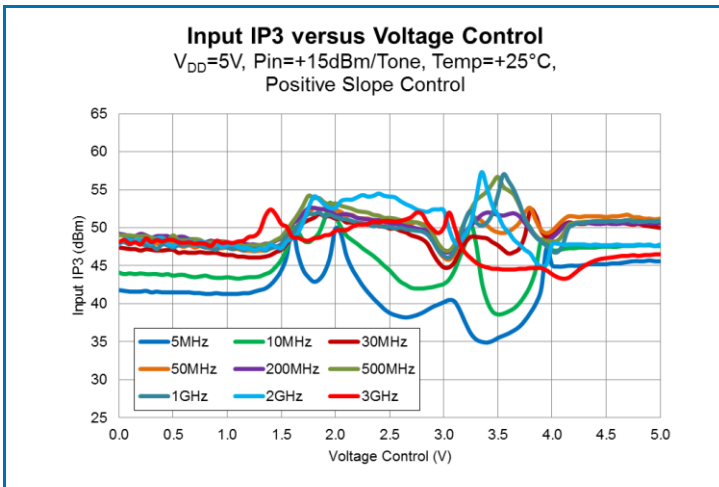
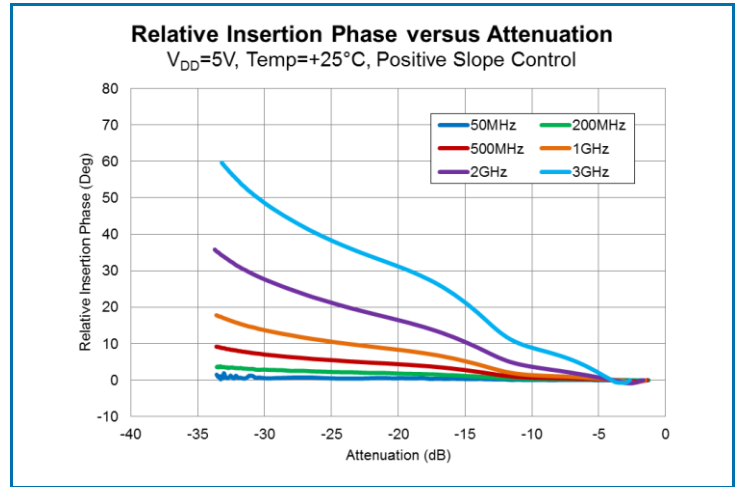
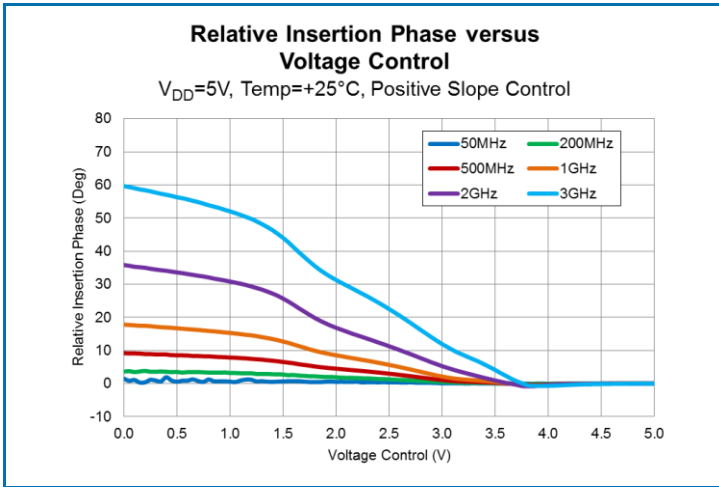

Typical Performance: 5MHz to 3000MHz Application Circuit

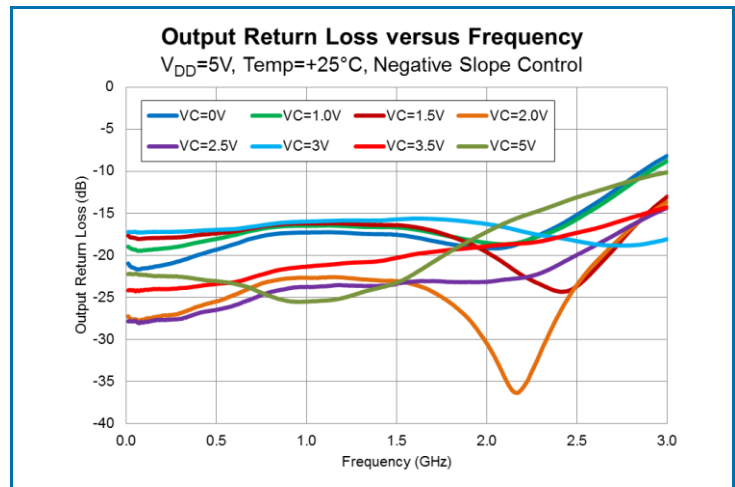
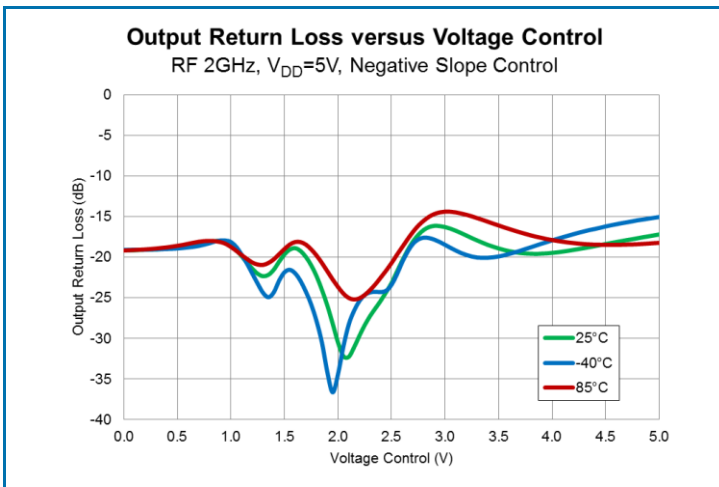
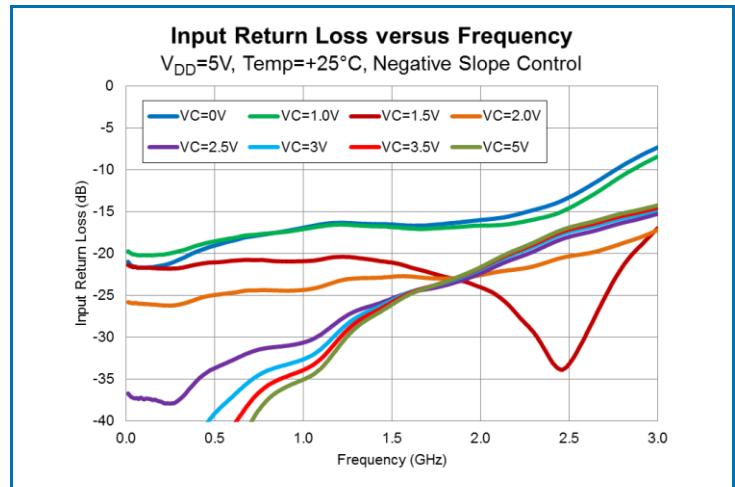
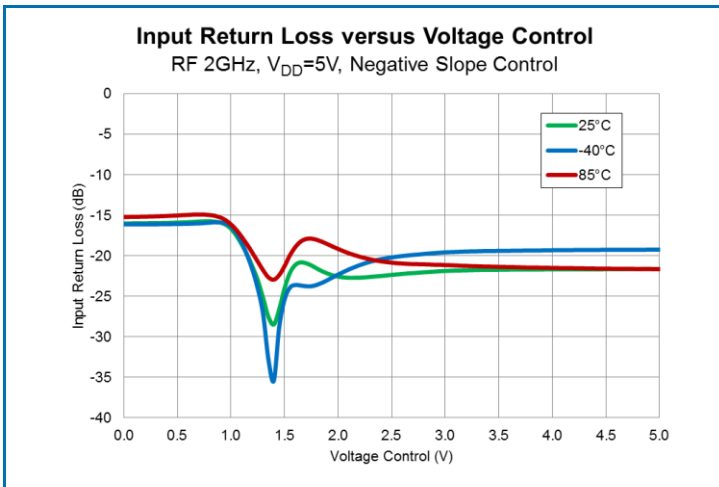
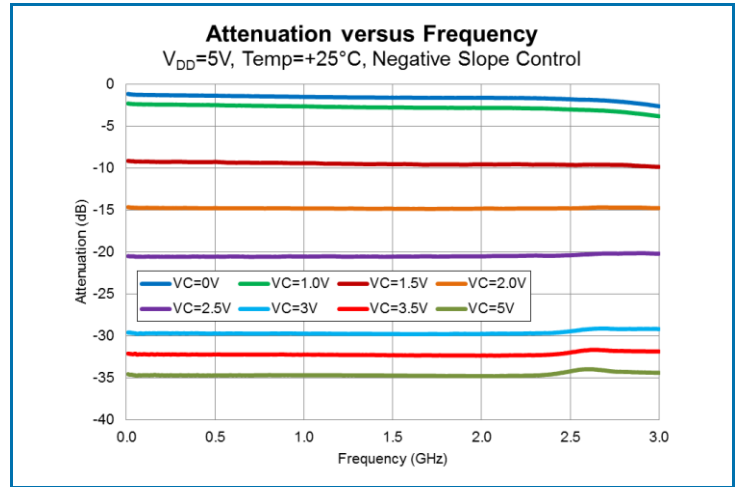
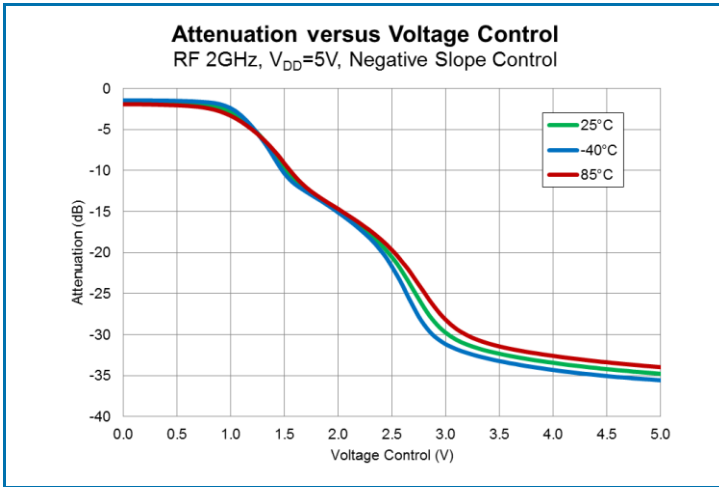

Typical Performance: 5MHz to 3000MHz Application Circuit

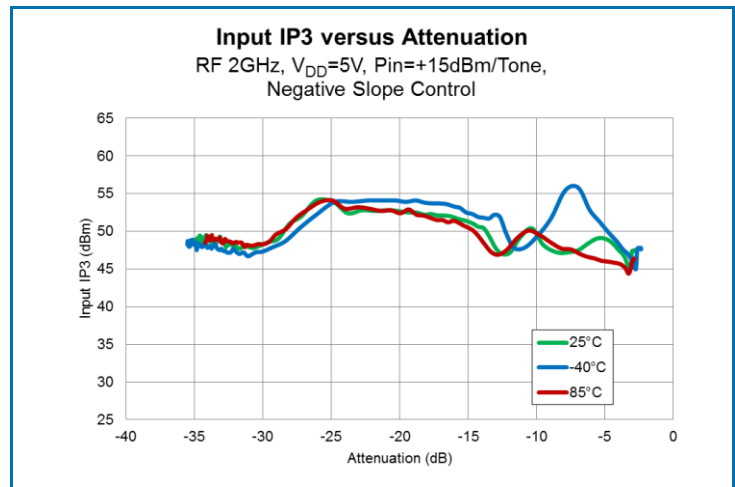
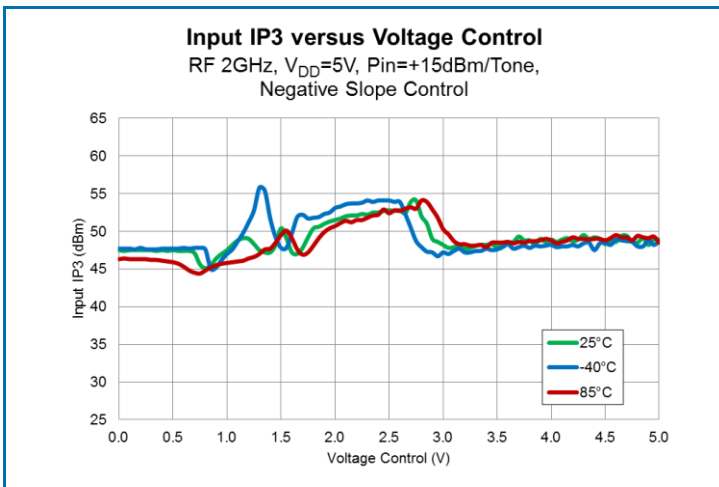
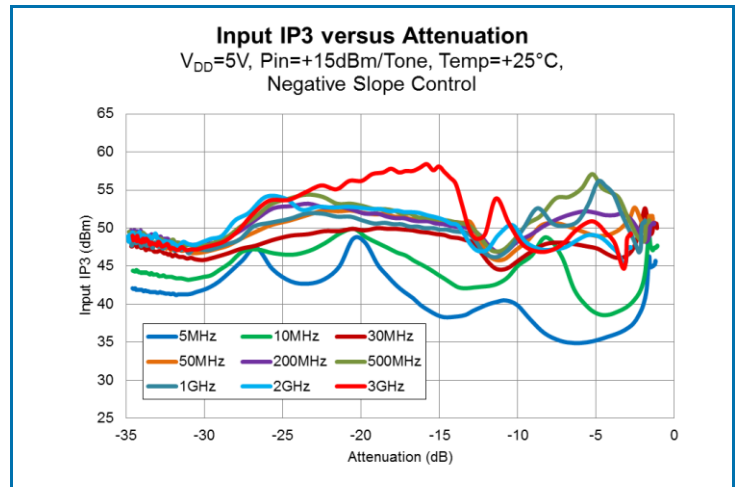
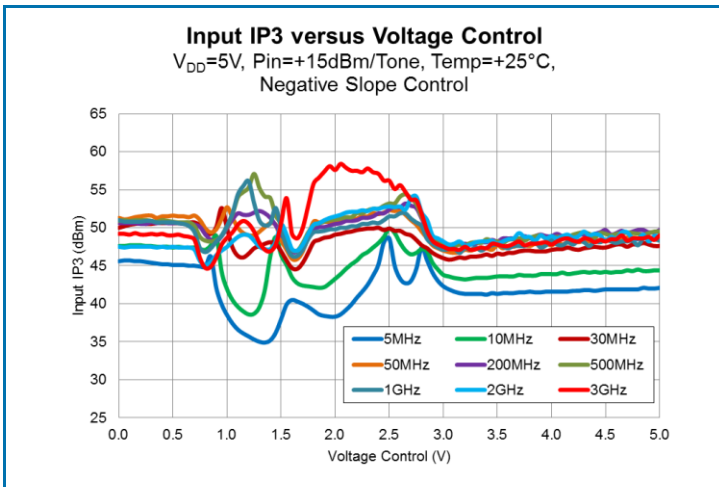
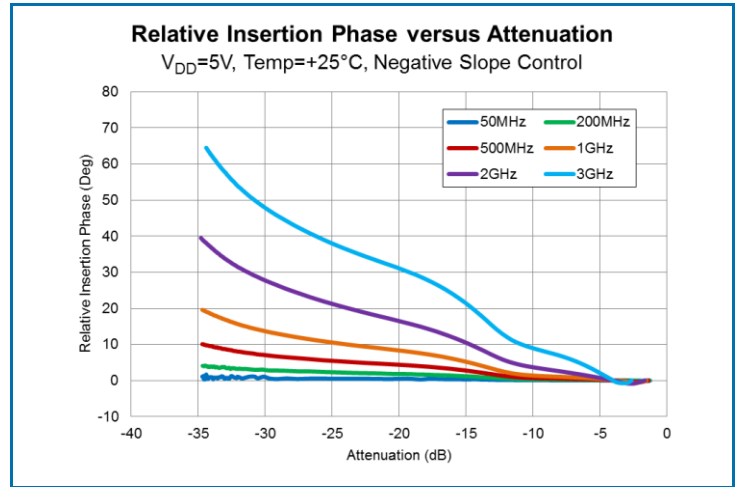
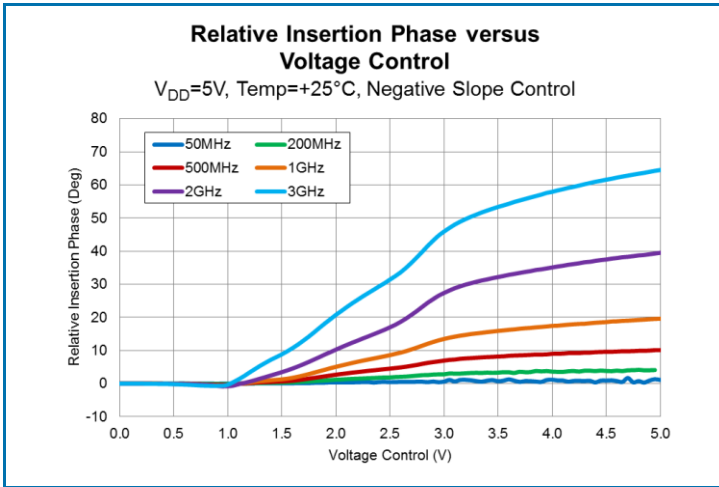

Typical Application Schematic 5MHz to 3000MHz Application Circuit

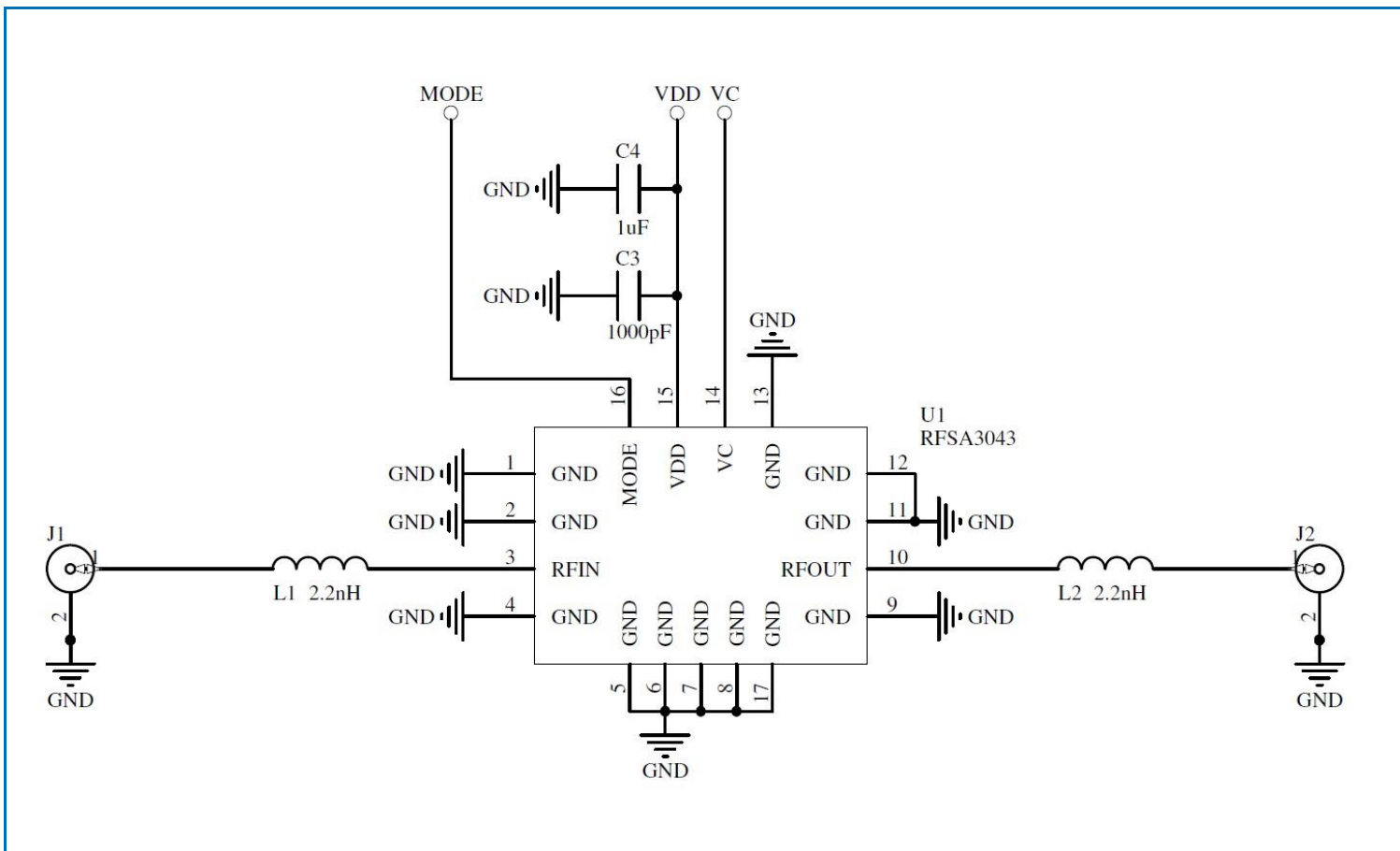

Evaluation Board Bill of Materials (BOM) 5MHz to 1200MHz Application Circuit

Description	Reference Designator	Manufacturer	Manufacturer's P/N
Voltage Controlled Attenuator, VCA, 5V	U1	RFMD	RFSA3043
CONN, F FEM EDGE MOUNT, 75Ω, 0.065"	J1-J4	Genesis Technology USA	GT20-300204
CONN, HDR, ST, 4-PIN, 0.100"	P1	Samtec, Inc.	TSW-104-08-S-S
SA3043-410 Evaluation Board		DDI	SA3043-410(B)
CAP, 1000pF, 10%, 25V, X7R, 0402	C3	Murata Electronics	GRM155R71H102KA01D
CAP, 1µF, 10%, 16V, X7R, 1206	C4	Murata Electronics	GRM31MR71E105KC01L
RES, 0Ω, 0402 KAMAYA	L1-L2	Kamaya, Inc.	RMC1/16SJPTH
DNP	C1-C2, C5	N/A	N/A

Evaluation Board Assembly Drawing

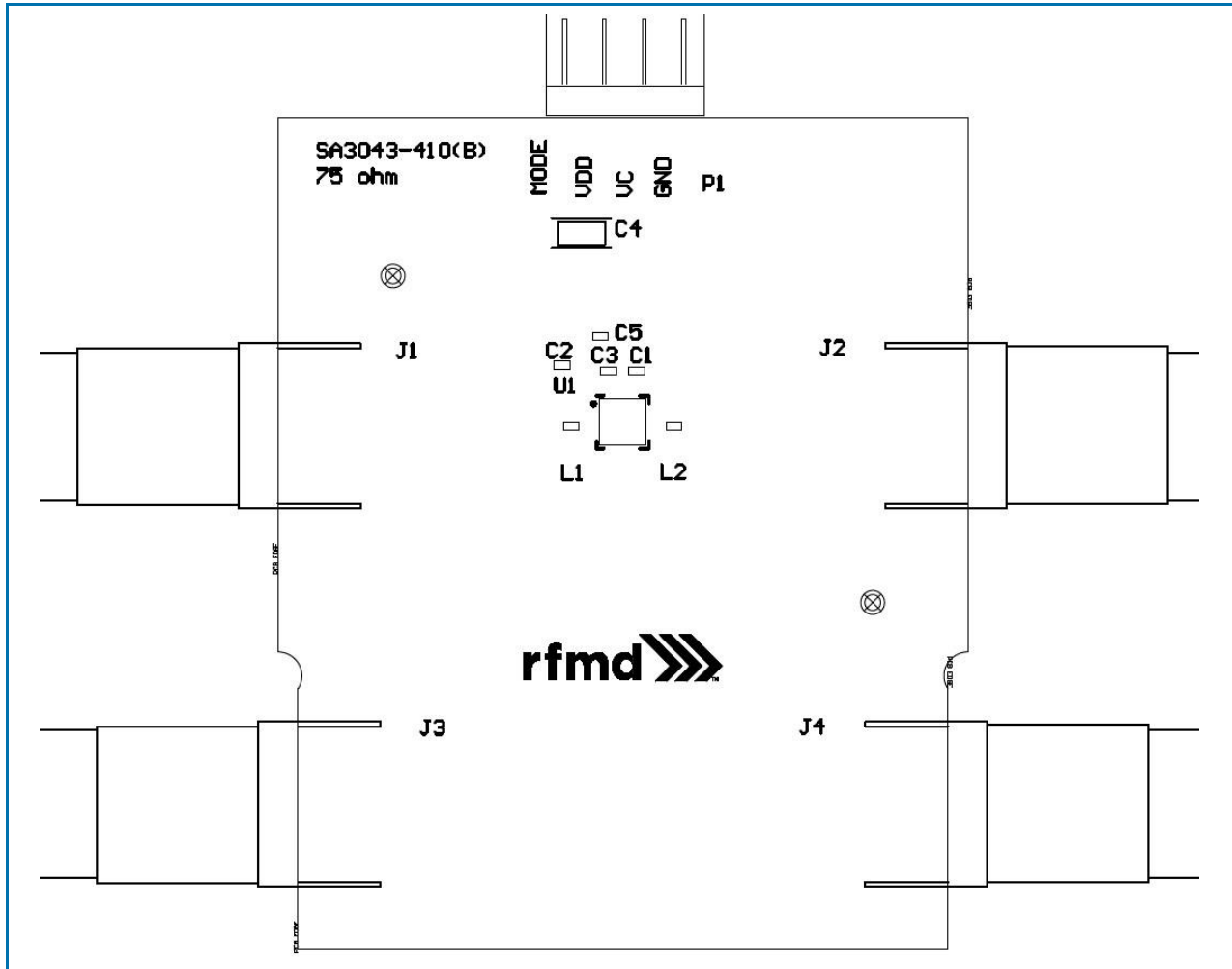

Evaluation Board Schematic 5MHz to 1200MHz Application Circuit

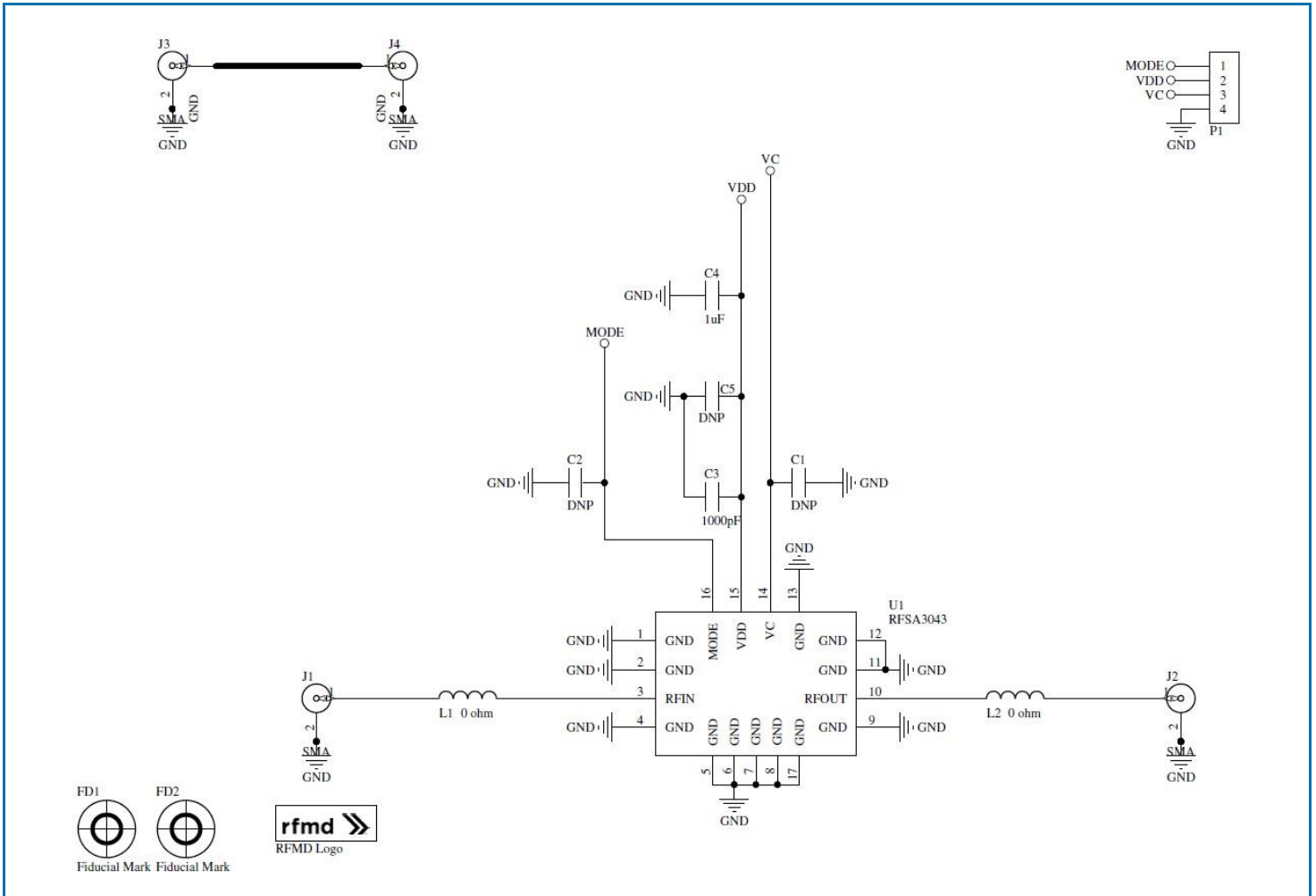

Pin Names and Descriptions

Pin	Name	Description
1	GND	Ground Pin
2	GND	Ground Pin
3	RFIN	RF Input; Use external DC block, RF input must be this pin to insure linearity and thermal resistance specifications
4	GND	Ground Pin
5	GND	Ground Pin
6	GND	Ground Pin
7	GND	Ground Pin
8	GND	Ground Pin
9	GND	Ground Pin
10	RFOUT	RF Output, Use external DC block, RF output must be this pin to insure linearity and thermal resistance specifications
11	GND	Ground Pin
12	GND	Ground Pin
13	GND	Ground Pin
14	VC	Attenuator Control Voltage
15	VDD	Supply Voltage
16	MODE	Attenuation Slope Control Set to logic low to enable negative attenuation slope Set to logic high to enable positive attenuation slope

Package Outline Drawing (Dimensions in millimeters)

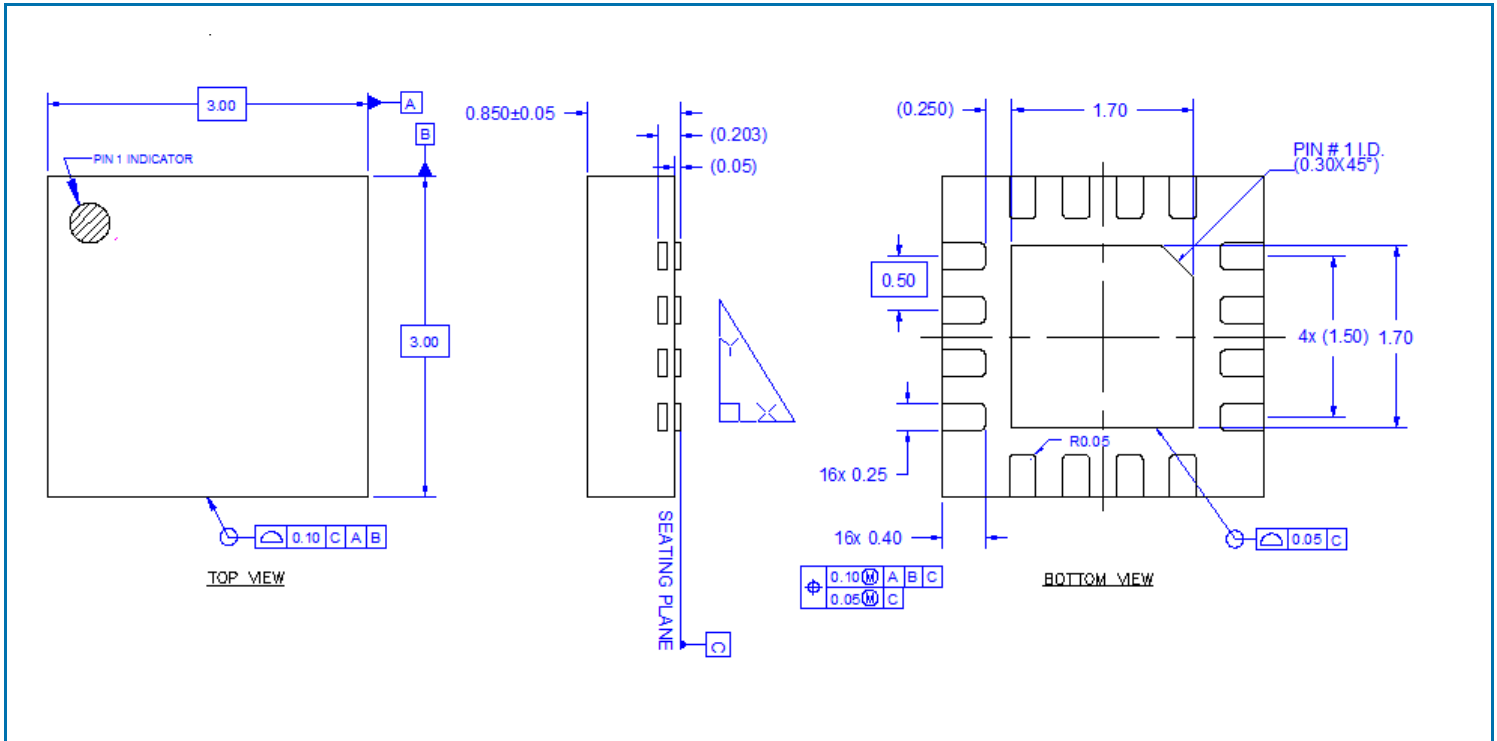

Branding Diagram

