

- Low Insertion Loss SAW RF Filter
- 3.0 x 3.0 x 1.3 mm Surface-Mount Case
- No Matching Circuit Required
- Complies with Directive 2002/95/EC (RoHS) 

**Absolute Maximum Ratings**

Rating	Value	Units
Input Power Level	+10	dBm
DC Voltage on any Non-ground Terminal	3	Volts
Operating Temperature Range	-20 to +70	°C
Storage Temperature Range in Tape and Reel	-30 to +85	°C
Maximum Soldering Profile, 5 Cycles/10 seconds Maximum	265	°C

**SF2161E**

**2650 MHz  
SAW Filter**

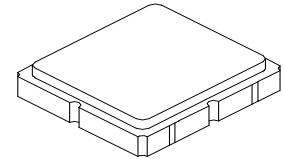

**SM3030-6**

**Electrical Characteristics**

Characteristic	Sym	Notes	Min	Typ	Max	Units
Center Frequency	$f_c$	1		2650		MHz
Insertion Loss	IL			2.0	3.5	MHz
Amplitude Ripple, 2615 to 2685 MHz				0.9	2.5	dB <sub>P-P</sub>
Attenuation Referenced to 0 dB:						
DC to 2300 MHz			23.0	27.5		dB
2300 to 2500 MHz			25.0	32.0		
2800 to 4000 MHz			30.0	34.0		
4000 to 5000 MHz			20.0	32		
VSWR, 2615 to 2685 MHz				1.6:1	2.3:1	
Source Impedance	$Z_S$			50		$\Omega$
Load Impedance	$Z_L$			50		$\Omega$

Single-Ended Input / Output Impedance Match	No matching network required for operation at 50 ohms
Case Style	SM3030-6 3 x 3 mm Nominal Footprint
Lid Symbolization, Y=year, WW=week, S=shift	848 YWWS

**Electrical Connections**

Connection	Terminals
Input	2
Output	5
Ground	All others

 **CAUTION: Electrostatic Sensitive Device. Observe precautions for handling.**  
**NOTES:**

1. Unless noted otherwise, all specifications apply over the operating temperature range with filter soldered to the specified demonstration board with impedance matching to 50  $\Omega$  and measured with 50  $\Omega$  network analyzer.
2. Unless noted otherwise, all frequency specifications are referenced to the nominal center frequency,  $f_c$ .
3. Rejection is measured as attenuation below the minimum IL point in the passband. Rejection in final user application is dependent on PCB layout and external impedance matching design. See Application Note No. 42 for details.
4. "LRIP" or "L" after the part number indicates "low rate initial production" and "ENG" or "E" indicates "engineering parts."
5. The design, manufacturing process, and specifications of this filter are subject to change.
6. Either Port 1 or Port 2 may be used for either input or output in the design. However, impedances and impedance matching may vary between Port 1 and Port 2, so that the filter must always be installed in one direction per the circuit design.
7. US and international patents may apply.
8. Murata, stylized Murata logo, and Murata N.A., Inc. are registered trademarks of Murata Manufacturing Co., Ltd.

# Broadband Filter Response

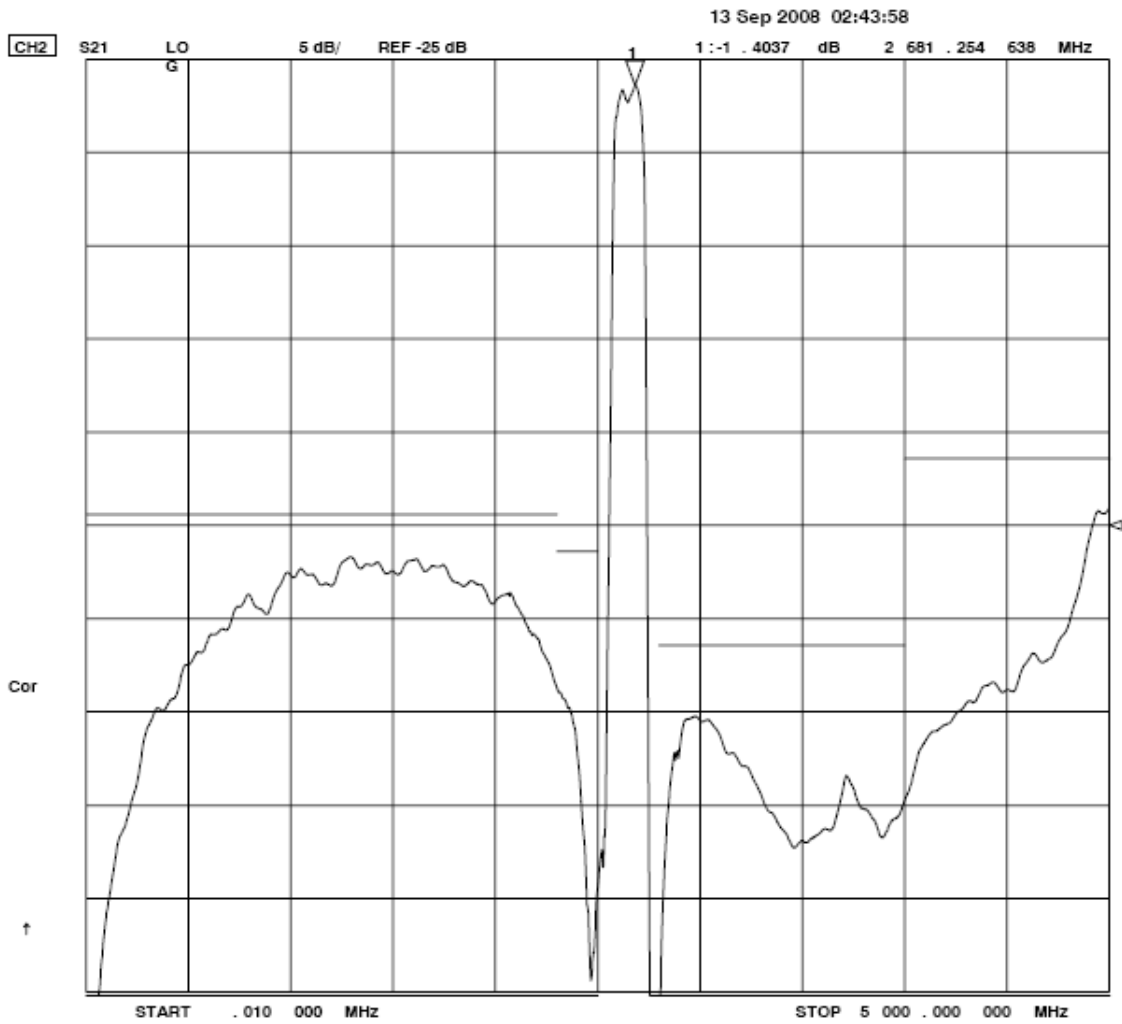

# Passband Filter Response

3 Sep 2008 14:02:47

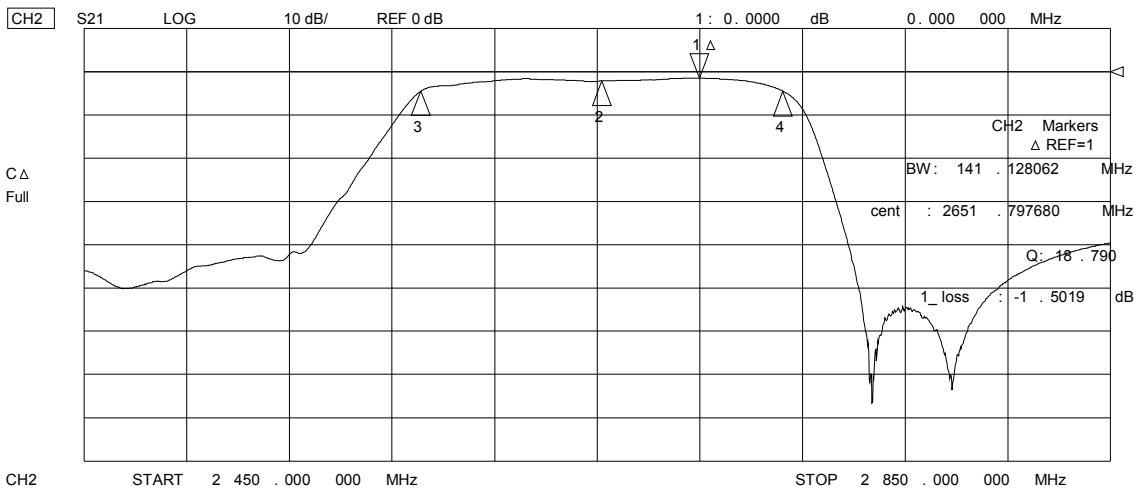
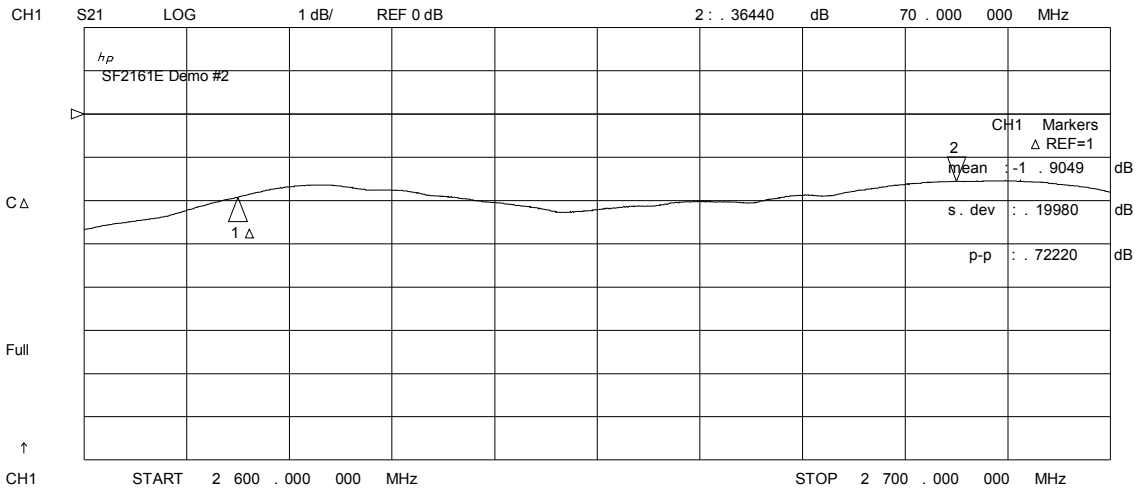

# SM3030-6 Case

## 6-Terminal Ceramic Surface-Mount Case 3.0 X 3.0 mm Nominal Footprint

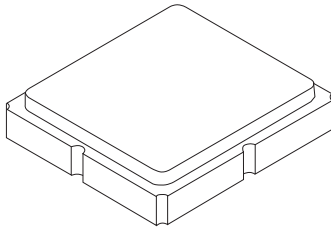

PCB Footprint Top View

### Case and PCB Footprint Dimensions

Dimension	mm			Inches		
	Min	Nom	Max	Min	Nom	Max
A	2.87	3.00	3.13	0.113	0.118	0.123
B	2.87	3.00	3.13	0.113	0.118	0.123
C	1.12	1.25	1.38	0.044	0.049	0.054
D	0.77	0.90	1.03	0.030	0.035	0.040
E	2.67	2.80	2.93	0.105	0.110	0.115
F	1.47	1.60	1.73	0.058	0.063	0.068
G	0.72	0.85	0.98	0.028	0.033	0.038
H	1.37	1.50	1.63	0.054	0.059	0.064
I	0.47	0.60	0.73	0.019	0.024	0.029
J	1.17	1.30	1.43	0.046	0.051	0.056
K		3.20			0.126	
L		1.70			0.067	
M		1.05			0.041	
N		0.81			0.032	
O		0.38			0.015	

### Case Materials

Materials	
Solder Pad Plating	0.3 to 1.0 $\mu\text{m}$ Gold over 1.27 to 8.89 $\mu\text{m}$ Nickel
Lid Plating	2.0 to 3.0 $\mu\text{m}$ Nickel
Body	$\text{Al}_2\text{O}_3$ Ceramic
Pb Free	

### Top View

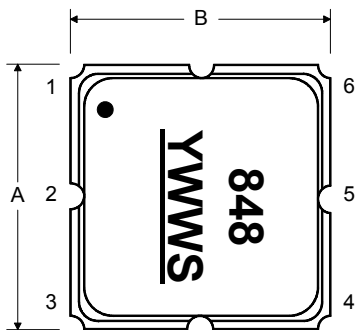

### Bottom View

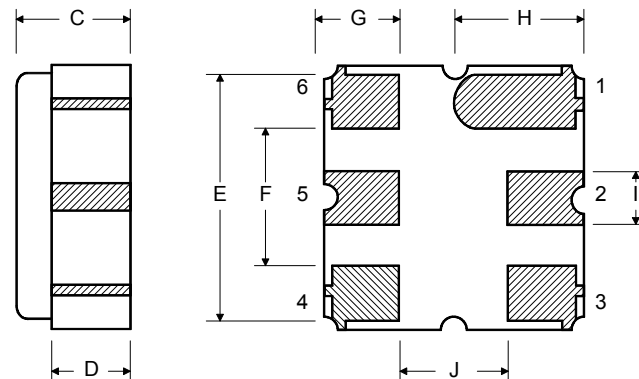

## Tape and Reel Specifications

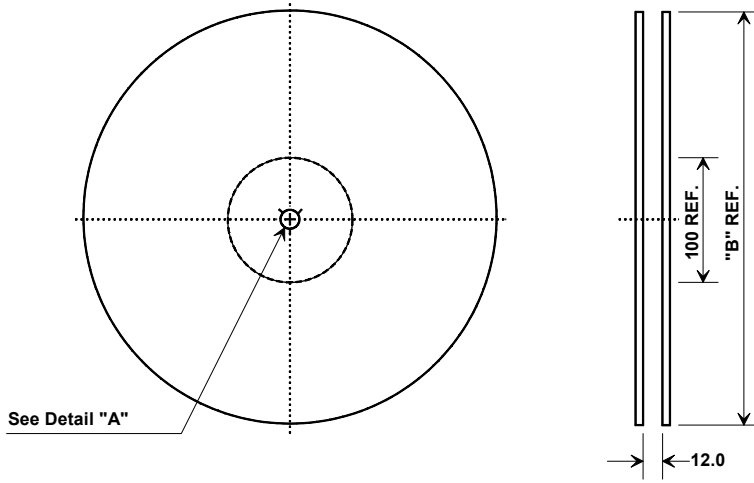

"B"		Quantity Per Reel
Inches	millimeters	
7	178	500
13	330	3000

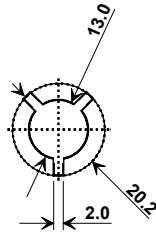

## COMPONENT ORIENTATION and DIMENSIONS

Carrier Tape Dimensions	
Ao	3.35 mm
Bo	3.35 mm
Ko	1.40 mm
Pitch	8.0 mm
W	12.0 mm

