

Low to Medium Power UHF Broadcast Antennas

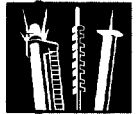

Broadcast Antenna Systems

ALP Series II Antennas

New Andrew ALP Series II antennas deliver the versatility, power, and reliability that are the keys to success in today's competitive broadcast marketplace.

For full-power stations transitioning to DTV, ALP Series II antennas offer field-proven solutions. Broadcasters with medium power requirements can benefit from this antenna's lightweight, low windloads, and easy installation which provide reductions in installation time and costs.

For Low Power Television (LPTV) stations the new, higher power handling capabilities of the ALP Series II UHF antennas make them the ideal choice for the higher ERPs now allowed for LPTV stations and translator facilities. The ALP Series II antennas offer the quality and performance needed to improve coverage and maintain competitiveness in today's broadcast marketplace.

- *Available for immediate implementation of DTV channels*
- *All CCIR bands IV/V channels available*
- *Lightweight/low wind load*
 - *Easy to install with less expense*
 - *Easier to lease tower space*
- *Radome enclosed for environmental protection*
 - *Long Life*
 - *Low maintenance*
 - *Reliable*
- *Power ratings up to 28 kW (peak) available*
- *Customized patterns*
 - *Optimize coverage for your market area*
- *Wide selection of "off the shelf" patterns*
 - *Simplified application process*
- *Patterns measured at factory*
 - *Reliable performance in the field*
 - *Superior coverage*
- *Special designs available*
 - *Circular polarization (low and medium power)*
 - *Broadband versions available*

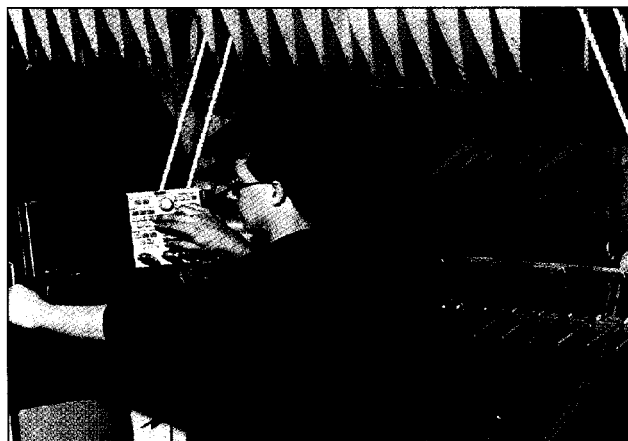
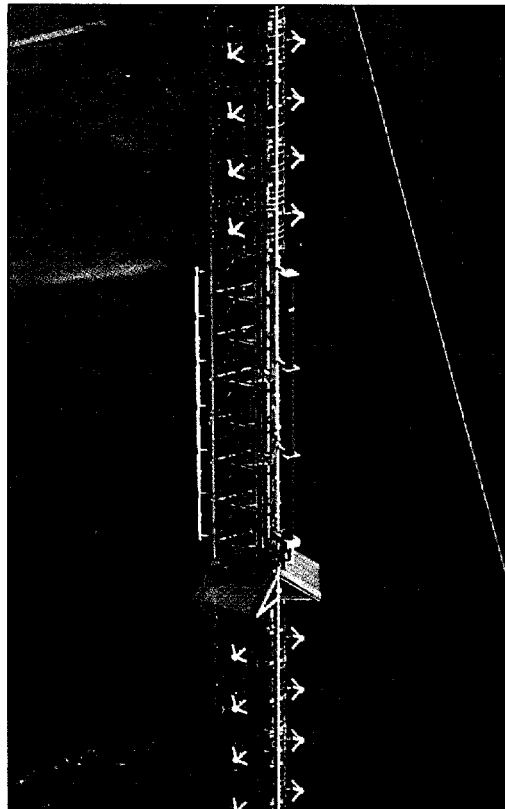



ALP Series II Antennas

Azimuth Patterns

UHF Low and Medium Power Antenna Systems

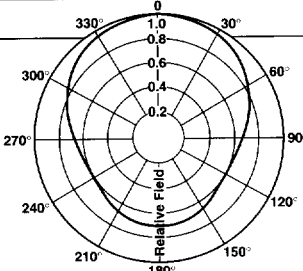
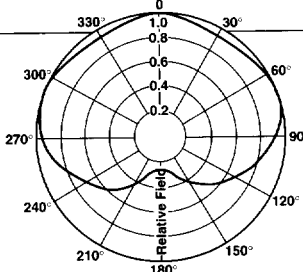
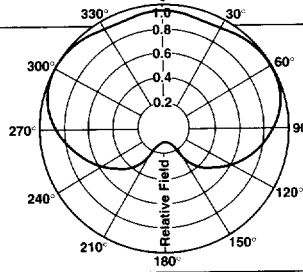
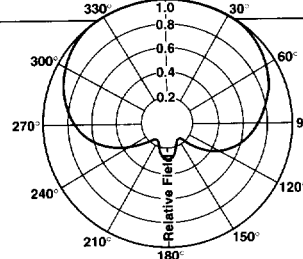
Number of Bays	Antenna Type Number	Power Gain (dBd)		
OmnioiTM (Omnidirectional)				
4	ALP4†1-HSOC- (*)	7.79 (8.91)		Directivity 1.70 (2.30 dB) Pattern: OC
8	ALP8†1-HSOC- (*)	15.39 (11.87)		
12	ALP12†2-HSOC- (*)	21.49 (13.32)		
16	ALP16†2-HSOC- (*)	28.20 (14.50)		
24	ALP24†3-HSOC- (*)	42.86 (16.32)		
32	ALP32†3-HSOC- (*)	54.28 (17.35)		
Wide Cardioid				
4	ALP4†1-HSW- (*)	7.14 (8.54)		Directivity 1.56 (1.93 dB) Pattern: W
8	ALP8†1-HSW- (*)	14.12 (11.50)		
12	ALP12†2-HSW- (*)	19.72 (12.95)		
16	ALP16†2-HSW- (*)	25.88 (14.13)		
24	ALP24†3-HSW- (*)	39.33 (15.95)		
32	ALP32†3-HSW- (*)	49.81 (16.97)		
Wide Cardioid - Reduced Rear (H-pol only)				
4	ALP4†1-HSWR- (*)	7.74 (8.89)		Directivity 1.69 (2.28 dB) Pattern: WR
8	ALP8†1-HSWR- (*)	15.29 (11.85)		
12	ALP12†2-HSWR- (*)	21.36 (13.30)		
16	ALP16†2-HSWR- (*)	28.04 (14.48)		
24	ALP24†3-HSWR- (*)	42.60 (16.30)		
32	ALP32†3-HSWR- (*)	53.96 (17.32)		
Extended Cardioid				
4	ALP4†1-HSE- (*)	8.52 (9.30)		Directivity 1.86 (2.70 dB) Pattern: E
8	ALP8†1-HSE- (*)	16.83 (12.26)		
12	ALP12†2-HSE- (*)	23.51 (13.71)		
16	ALP16†2-HSE- (*)	30.86 (14.89)		
24	ALP24†3-HSE- (*)	46.89 (16.71)		
32	ALP32†3-HSE- (*)	59.39 (17.74)		

† Insert "L" for low power or "M" for medium power.
 * Insert channel number (14 to 69).
 Note: C-Pol antenna azimuth patterns only available in E, M, N, OC, P, and W.



ALP Series II Antennas Azimuth Patterns



UHF Low and Medium Power Antenna Systems

Number of Bays	Antenna Type Number	Power Gain (dBd)		
Extended Cardioid - Reduced Rear (H-pol only)				
4	ALP4†1-HSER- (*)	8.84 (9.46)		Directivity 1.93 (2.86 dB) Pattern: ER
8	ALP8†1-HSER- (*)	17.47 (12.42)		
12	ALP12†2-HSER- (*)	24.40 (13.87)		
16	ALP16†2-HSER- (*)	32.02 (15.05)		
24	ALP24†3-HSER- (*)	48.66 (16.87)		
32	ALP32†3-HSER- (*)	61.62 (17.90)		
Medium Cardioid				
4	ALP4†1-HSM- (*)	11.63 (10.66)		Directivity 2.54 (4.05 dB) Pattern: M
8	ALP8†1-HSM- (*)	22.99 (13.61)		
12	ALP12†2-HSM- (*)	32.11 (15.07)		
16	ALP16†2-HSM- (*)	42.14 (16.25)		
24	ALP24†3-HSM- (*)	64.03 (18.06)		
32	ALP32†3-HSM- (*)	81.10 (19.09)		
Medium Cardioid - Reduced Rear (H-pol only)				
4	ALP4†1-HSMR- (*)	12.92 (11.11)		Directivity 2.82 (4.50 dB) Pattern: MR
8	ALP8†1-HSMR- (*)	25.52 (14.07)		
12	ALP12†2-HSMR- (*)	35.64 (15.52)		
16	ALP16†2-HSMR- (*)	46.78 (16.70)		
24	ALP24†3-HSMR- (*)	71.09 (18.52)		
32	ALP32†3-HSMR- (*)	90.04 (19.54)		
Narrow Cardioid				
4	ALP4†1-HSN- (*)	17.27 (12.37)		Directivity 3.77 (5.76 dB) Pattern: N
8	ALP8†1-HSN- (*)	34.12 (15.33)		
12	ALP12†2-HSN- (*)	47.65 (16.78)		
16	ALP16†2-HSN- (*)	62.54 (17.96)		
24	ALP24†3-HSN- (*)	95.04 (19.78)		
32	ALP32†3-HSN- (*)	120.38 (20.81)		
Narrow Cardioid - Reduced Rear (H-pol only)				
4	ALP4†1-HSNR- (*)	17.40 (12.41)		Directivity 3.80 (5.80 dB) Pattern: NR
8	ALP8†1-HSNR- (*)	34.39 (15.36)		
12	ALP12†2-HSNR- (*)	48.03 (16.82)		
16	ALP16†2-HSNR- (*)	63.04 (18.00)		
24	ALP24†3-HSNR- (*)	95.80 (19.81)		
32	ALP32†3-HSNR- (*)	121.33 (20.84)		

† Insert "L" for low power or "M" for medium power.

* Insert channel number (14 to 69)

Note: C-Pol antenna azimuth patterns only available in E, M, N, OC, P, and W.

Broadcast Antenna Systems



ALP Series II Antennas

Azimuth Patterns

UHF Low and Medium Power Antenna Systems

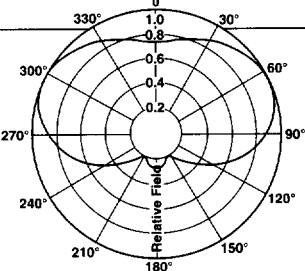
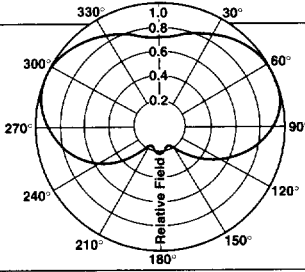
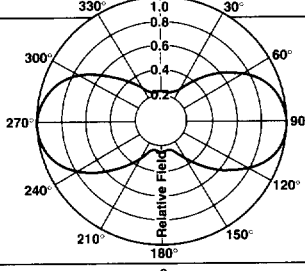
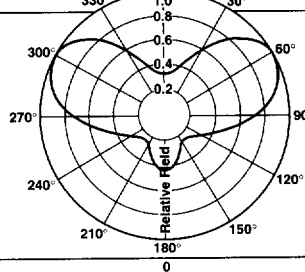
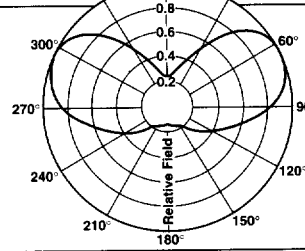
Number of Bays	Antenna Type Number	Power Gain (dBd)		
Peanut				
4	ALP4†1-HSP- (*)	8.61 (9.35)		Directivity 1.88 (2.74 dB) Pattern: P
8	ALP8†1-HSP- (*)	17.01 (12.31)		
12	ALP12†2-HSP- (*)	23.76 (13.76)		
16	ALP16†2-HSP- (*)	31.19 (14.94)		
24	ALP24†3-HSP- (*)	47.39 (16.76)		
32	ALP32†3-HSP- (*)	60.03 (17.78)		
Peanut - Reduced Rear (H-pol only)				
4	ALP4†1-HSPR- (*)	8.79 (9.44)		Directivity 1.92 (2.83 dB) Pattern: PR
8	ALP8†1-HSPR- (*)	17.38 (12.40)		
12	ALP12†2-HSPR- (*)	24.27 (13.85)		
16	ALP16†2-HSPR- (*)	31.85 (15.03)		
24	ALP24†3-HSPR- (*)	48.40 (16.85)		
32	ALP32†3-HSPR- (*)	61.31 (17.88)		
H-Pattern Peanut (H-pol only)				
4	ALP4†1-HSH- (*)	11.27 (10.52)		Directivity 2.46 (3.91 dB) Pattern: H
8	ALP8†1-HSH- (*)	22.26 (13.48)		
12	ALP12†2-HSH- (*)	31.09 (14.93)		
16	ALP16†2-HSH- (*)	40.81 (16.11)		
24	ALP24†3-HSH- (*)	62.02 (17.93)		
32	ALP32†3-HSH- (*)	78.55 (18.95)		
Butterfly (H-pol only)				
4	ALP4†1-HSB- (*)	12.23 (10.87)		Directivity 2.67 (4.27 dB) Pattern: B
8	ALP8†1-HSB- (*)	24.16 (13.83)		
12	ALP12†2-HSB- (*)	33.75 (15.28)		
16	ALP16†2-HSB- (*)	44.30 (16.46)		
24	ALP24†3-HSB- (*)	67.31 (18.28)		
32	ALP32†3-HSB- (*)	85.25 (19.31)		
Butterfly - Reduced Rear (H-pol only)				
4	ALP4†1-HSBR- (*)	12.60 (11.00)		Directivity 2.75 (4.39 dB) Pattern: BR
8	ALP8†1-HSBR- (*)	24.89 (13.96)		
12	ALP12†2-HSBR- (*)	34.76 (15.41)		
16	ALP16†2-HSBR- (*)	45.62 (16.59)		
24	ALP24†3-HSBR- (*)	69.33 (18.41)		
32	ALP32†3-HSBR- (*)	87.81 (19.44)		

† Insert "L" for low power or "M" for medium power.
 * Insert channel number (14 to 69).
 Note: C-Pol antenna azimuth patterns only available in E, M, N, OC, P, and W.



ALP Series II Antennas Elevation Patterns

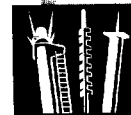

Broadcast Antenna Systems

4 Bay
Directivity 4.58
(6.61 dBd)
Beam Tilt 0°

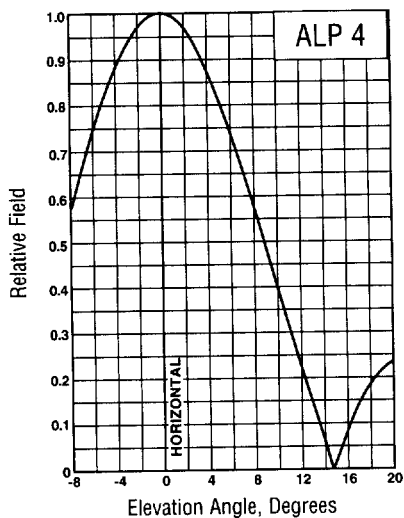

8 Bay
Directivity 9.05
(9.57 dBd)
Beam Tilt 0.25°

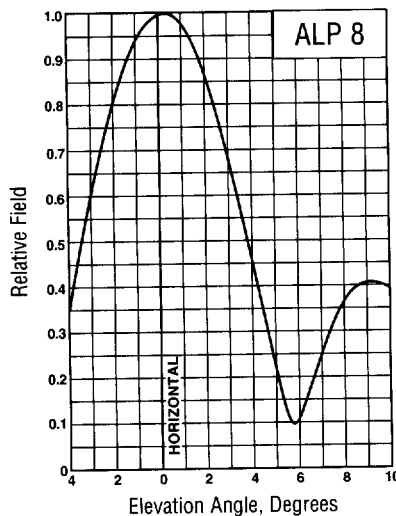

12 Bay
Directivity 12.64
(11.02 dBd)
Beam Tilt 0.5°

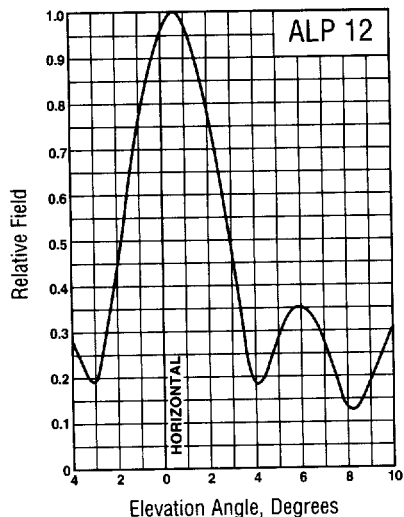

16 Bay
Directivity 16.59
(12.20 dBd)
Beam Tilt 0.5°

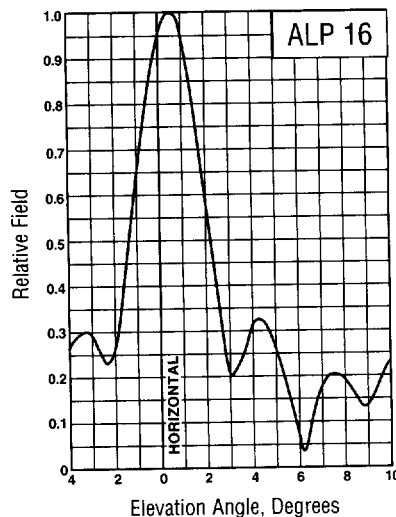

24 Bay
Directivity 25.21
(14.02 dBd)
Beam Tilt 0.75°

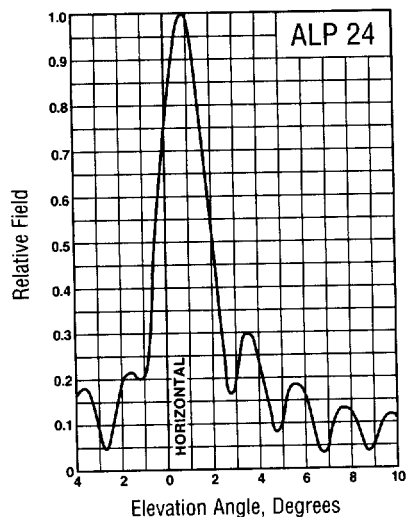

32 Bay
Directivity 31.93
(15.04 dBd)
Beam Tilt 0.75°

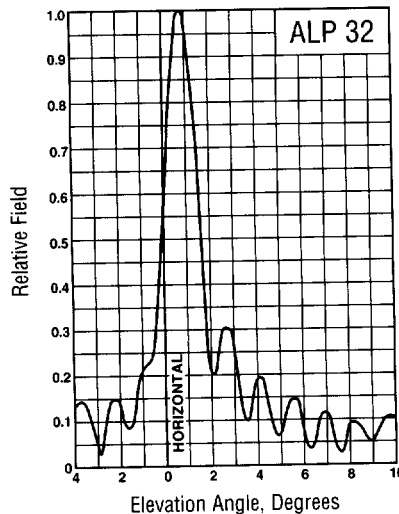

Note: Standard beamtilts are shown for each antenna model. Additional beamtilt up to 3.0° is available at an extra charge. See ordering information on page 299.

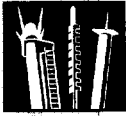

ALP Series II Antennas

Mechanical Drawings

Broadcast Antenna Systems

H-Pol Side Mounting Details

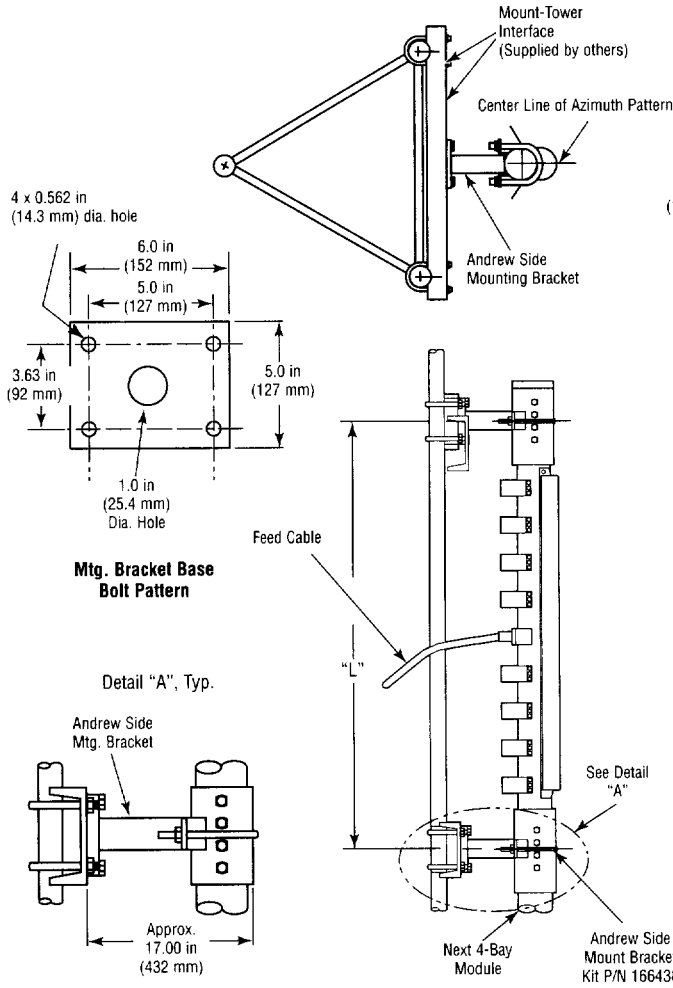

C-Pol Side Mounting Details

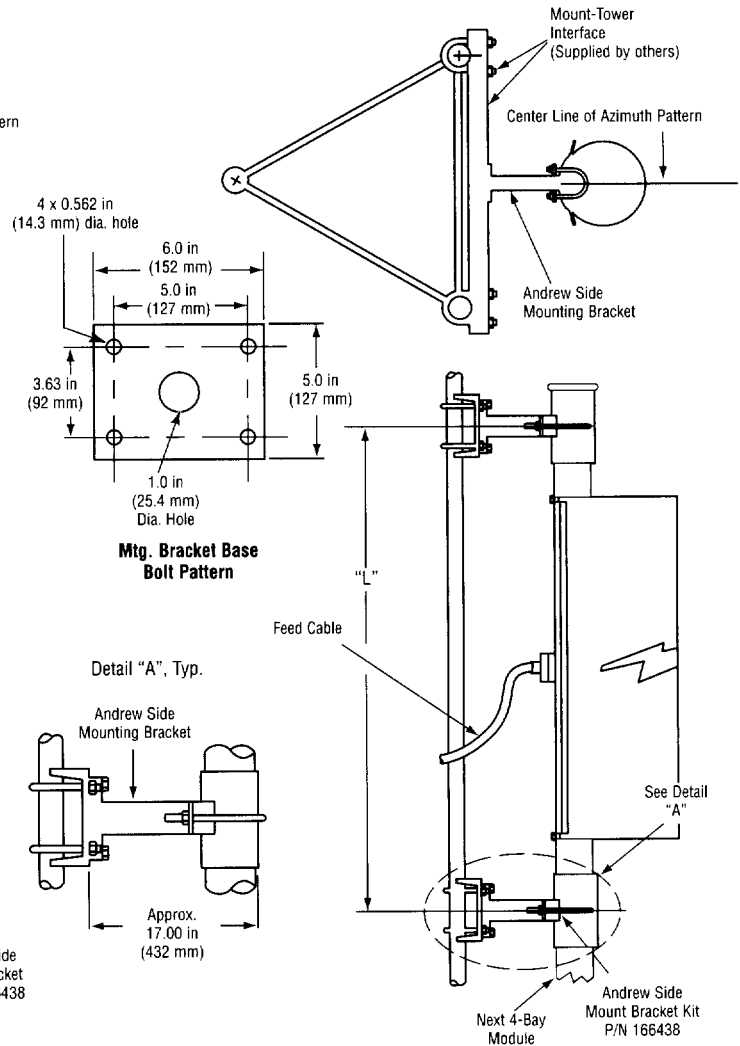

ALP Series II Antennas

Antenna Selection and Ordering Information



VSWR. All single channel antennas listed meet the following maximum VSWR specifications:

Visual Carrier + 0.5 MHz	1.05:1
Color Subcarrier	1.08:1
Remainder of channel	1.10:1

Mounting. Andrew does not supply the interface between mount and tower.

To Order:

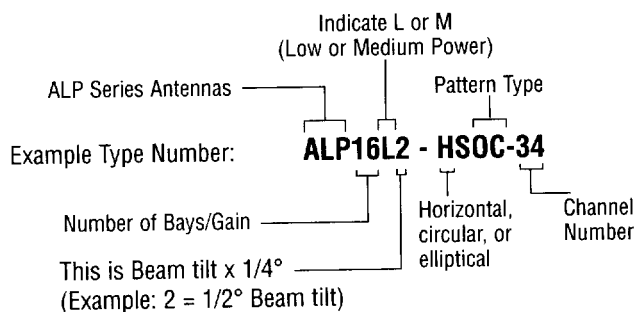

The example antenna is a low power version of a 16 bay, horizontally polarized, omnidirectional antenna, with a beam tilt of 1/2°, for channel 34.

Mounting Brackets		Channel	"L" in (mm)
Bays	Required		
4	2	14-24	120.0 (3048)
8	3	25-30	114.0 (2896)
12	4	31-37	108.0 (2743)
16	5	38-45	102.0 (2591)
24	7	46-53	96.0 (2438)
32	9	54-61	90.0 (2286)
		62-69	84.0 (2134)

Wide band antennas are specified similar to standard single channel antennas, except the applicable channels and bandwidth of the antenna are specified in the final three digits as follows:

The first two digits represent the number of the UHF channel at the bottom of the band requested.

The third digit represents the number of 6 MHz channels covered (5 for 30 MHz bandwidth or 3 for 18 MHz bandwidth).

For example: **ALP16L2-HSOC-425**

The example antenna is a low power version of a 16 bay omnidirectional antenna, with a beam tilt of 1/2°, which covers channels 42 through 46 (30 MHz).

For complete specifications on wide band versions, call **1-800-DIAL-4RF.**



ALP Series II Antennas Mechanical Data

H-pol Specifications

Channel Number	Diameter Inches (mm)	Height ft (m)	Weight lb (kg)	Wind Load† lb (N)	L-Series		M-Series	
					Peak Power Rating**	Input (50 ohm)	Peak Power Rating**	Input (50 ohm)
4 Bay								
14-24	3.5 (89)	10.8 (3.3)	60 (27)	200 (890)	3 kW	7/8" EIA	3 kW	7/8" EIA
25-30	3.5 (89)	10.3 (3.1)	60 (27)	200 (890)	3 kW	7/8" EIA	3 kW	7/8" EIA
31-37	3.5 (89)	9.8 (2.9)	60 (27)	190 (845)	3 kW	7/8" EIA	3 kW	7/8" EIA
38-45	3.5 (89)	9.3 (2.8)	55 (25)	190 (845)	3 kW	7/8" EIA	3 kW	7/8" EIA
46-53	3.5 (89)	8.8 (2.7)	55 (25)	180 (800)	3 kW	7/8" EIA	3 kW	7/8" EIA
54-61	3.5 (89)	8.3 (2.5)	55 (25)	180 (800)	3 kW	7/8" EIA	3 kW	7/8" EIA
62-69	3.5 (89)	7.8 (2.4)	50 (23)	170 (755)	3 kW	7/8" EIA	3 kW	7/8" EIA
8 Bay								
14-24	3.5 (89)	20.8 (6.3)	120 (55)	390 (1730)	2 kW	1-5/8" EIA	7 kW	1-5/8" EIA
25-30	3.5 (89)	19.8 (6.0)	120 (55)	390 (1730)	2 kW	1-5/8" EIA	7 kW	1-5/8" EIA
31-37	3.5 (89)	18.8 (5.7)	120 (55)	370 (1645)	2 kW	1-5/8" EIA	7 kW	1-5/8" EIA
38-45	3.5 (89)	17.8 (5.4)	110 (50)	370 (1645)	2 kW	1-5/8" EIA	7 kW	1-5/8" EIA
46-53	3.5 (89)	16.8 (5.1)	110 (50)	350 (1555)	2 kW	1-5/8" EIA	7 kW	1-5/8" EIA
54-61	3.5 (89)	15.8 (4.8)	110 (50)	350 (1555)	2 kW	1-5/8" EIA	7 kW	1-5/8" EIA
62-69	3.5 (89)	14.8 (4.5)	100 (45)	330 (1465)	2 kW	1-5/8" EIA	7 kW	1-5/8" EIA
12 Bay								
14-24	3.5 (89)	30.8 (9.4)	175 (80)	580 (2580)	3 kW	1-5/8" EIA	17 kW	3-1/8" EIA
25-30	3.5 (89)	29.3 (8.9)	175 (80)	570 (2535)	3 kW	1-5/8" EIA	17 kW	3-1/8" EIA
31-37	3.5 (89)	27.8 (8.5)	170 (75)	550 (2445)	3 kW	1-5/8" EIA	17 kW	3-1/8" EIA
38-45	3.5 (89)	26.3 (8.0)	170 (75)	540 (2400)	3 kW	1-5/8" EIA	17 kW	3-1/8" EIA
46-53	3.5 (89)	24.8 (7.6)	165 (75)	520 (2310)	3 kW	1-5/8" EIA	17 kW	3-1/8" EIA
54-61	3.5 (89)	23.3 (7.1)	164 (75)	510 (2265)	3 kW	1-5/8" EIA	17 kW	3-1/8" EIA
62-69	3.5 (89)	21.8 (6.6)	160 (70)	490 (2180)	3 kW	1-5/8" EIA	17 kW	3-1/8" EIA
16 Bay								
14-24	3.5 (89)	40.8 (12.4)	240 (110)	780 (3470)	4 kW	1-5/8" EIA	22 kW	3-1/8" EIA
25-30	3.5 (89)	38.8 (11.8)	235 (105)	760 (3380)	4 kW	1-5/8" EIA	22 kW	3-1/8" EIA
31-37	3.5 (89)	36.8 (11.2)	230 (105)	740 (3290)	4 kW	1-5/8" EIA	22 kW	3-1/8" EIA
38-45	3.5 (89)	34.8 (10.6)	225 (100)	720 (3200)	4 kW	1-5/8" EIA	22 kW	3-1/8" EIA
46-53	3.5 (89)	32.8 (10.0)	220 (100)	700 (3110)	4 kW	1-5/8" EIA	22 kW	3-1/8" EIA
54-61	3.5 (89)	30.8 (9.4)	215 (100)	680 (3025)	4 kW	1-5/8" EIA	22 kW	3-1/8" EIA
62-69	3.5 (89)	28.8 (8.8)	210 (95)	660 (2935)	4 kW	1-5/8" EIA	22 kW	3-1/8" EIA
24 Bay								
14-24	3.5 (89)	60.8 (18.5)	350 (160)	1160 (5160)	6 kW	1-5/8" EIA	28 kW	3-1/8" EIA
25-30	3.5 (89)	57.8 (17.6)	340 (155)	1130 (5025)	6 kW	1-5/8" EIA	28 kW	3-1/8" EIA
31-37	3.5 (89)	54.8 (16.7)	330 (150)	1100 (4890)	6 kW	1-5/8" EIA	28 kW	3-1/8" EIA
38-45	3.5 (89)	51.8 (15.8)	320 (145)	1070 (4760)	6 kW	1-5/8" EIA	28 kW	3-1/8" EIA
46-53	3.5 (89)	48.8 (14.9)	310 (140)	1040 (4625)	6 kW	1-5/8" EIA	28 kW	3-1/8" EIA
54-61	3.5 (89)	45.8 (14.0)	300 (135)	1010 (4490)	6 kW	1-5/8" EIA	28 kW	3-1/8" EIA
62-69	3.5 (89)	42.8 (13.0)	290 (130)	980 (4360)	6 kW	1-5/8" EIA	28 kW	3-1/8" EIA
32 Bay								
14-24	3.5 (89)	80.8 (24.6)	440 (200)	1550 (6895)	8 kW	1-5/8" EIA	28 kW	3-1/8" EIA
25-30	3.5 (89)	76.8 (23.4)	430 (195)	1510 (6715)	8 kW	1-5/8" EIA	28 kW	3-1/8" EIA
31-37	3.5 (89)	72.8 (22.2)	420 (190)	1470 (6535)	8 kW	1-5/8" EIA	28 kW	3-1/8" EIA
38-45	3.5 (89)	68.8 (21.0)	410 (185)	1430 (6360)	8 kW	1-5/8" EIA	28 kW	3-1/8" EIA
46-53	3.5 (89)	64.8 (19.8)	400 (180)	1390 (6180)	8 kW	1-5/8" EIA	28 kW	3-1/8" EIA
54-61	3.5 (89)	60.8 (18.5)	390 (175)	1350 (6005)	8 kW	1-5/8" EIA	28 kW	3-1/8" EIA
62-69	3.5 (89)	56.8 (17.3)	380 (170)	1310 (5825)	8 kW	1-5/8" EIA	28 kW	3-1/8" EIA

Notes: † Loads are typical for 50 lb/ft² (2.4 kPa) for flat surfaces and 33 lb/ft² (1.6 kPa) for cylindrical surfaces.

* For wide Cardioid, Butterfly and all "Reduced Rear" azimuth patterns, multiply weight values by 1.05 and windload values by 1.25

** For average power rating, multiply (peak power x 0.7)



ALP Series II Antennas

Mechanical Data



Broadcast Antenna Systems

C-pol Specifications - C-pol Antenna azimuth patterns only available in E, M, N, OC, P, and W.

Channel Number	Diameter Inches (mm)	Height ft (m)	Weight lb (kg)	Wind Load† lb (N)	L-Series		M-Series	
					Peak Power Rating**	Input (50 ohm)	Peak Power Rating**	Input (50 ohm)
4 Bay								
14-24	3.5 (89)	10.8 (3.3)	75 (34)	850 (3780)	3 kW	7/8" EIA	3 kW	7/8" EIA
25-30	3.5 (89)	10.3 (3.1)	75 (34)	830 (3690)	3 kW	7/8" EIA	3 kW	7/8" EIA
31-37	3.5 (89)	9.8 (2.9)	75 (34)	810 (3600)	3 kW	7/8" EIA	3 kW	7/8" EIA
38-45	3.5 (89)	9.3 (2.8)	70 (32)	790 (3515)	3 kW	7/8" EIA	3 kW	7/8" EIA
46-53	3.5 (89)	8.8 (2.7)	70 (32)	770 (3425)	3 kW	7/8" EIA	3 kW	7/8" EIA
54-61	3.5 (89)	8.3 (2.5)	70 (32)	750 (3335)	3 kW	7/8" EIA	3 kW	7/8" EIA
62-69	3.5 (89)	7.8 (2.4)	65 (29)	730 (3245)	3 kW	7/8" EIA	3 kW	7/8" EIA
8 Bay								
14-24	3.5 (89)	20.8 (6.3)	140 (64)	1810 (8050)	2 kW	1-5/8" EIA	7 kW	1-5/8" EIA
25-30	3.5 (89)	19.8 (6.0)	140 (64)	1770 (7875)	2 kW	1-5/8" EIA	7 kW	1-5/8" EIA
31-37	3.5 (89)	18.8 (5.7)	140 (64)	1730 (7695)	2 kW	1-5/8" EIA	7 kW	1-5/8" EIA
38-45	3.5 (89)	17.8 (5.4)	130 (59)	1690 (7520)	2 kW	1-5/8" EIA	7 kW	1-5/8" EIA
46-53	3.5 (89)	16.8 (5.1)	130 (59)	1650 (7340)	2 kW	1-5/8" EIA	7 kW	1-5/8" EIA
54-61	3.5 (89)	15.8 (4.8)	130 (59)	1610 (7160)	2 kW	1-5/8" EIA	7 kW	1-5/8" EIA
62-69	3.5 (89)	14.8 (4.5)	120 (54)	1570 (6985)	2 kW	1-5/8" EIA	7 kW	1-5/8" EIA
12 Bay								
14-24	3.5 (89)	30.8 (9.4)	200 (91)	2670 (11875)	3 kW	1-5/8" EIA	12 kW	3-1/8" EIA
25-30	3.5 (89)	29.3 (8.9)	200 (91)	2610 (11610)	3 kW	1-5/8" EIA	12 kW	3-1/8" EIA
31-37	3.5 (89)	27.8 (8.5)	195 (88)	2550 (11345)	3 kW	1-5/8" EIA	12 kW	3-1/8" EIA
38-45	3.5 (89)	26.3 (8.0)	195 (88)	2490 (11075)	3 kW	1-5/8" EIA	12 kW	3-1/8" EIA
46-53	3.5 (89)	24.8 (7.6)	190 (86)	2430 (10810)	3 kW	1-5/8" EIA	12 kW	3-1/8" EIA
54-61	3.5 (89)	23.3 (7.1)	190 (86)	2370 (10540)	3 kW	1-5/8" EIA	12 kW	3-1/8" EIA
62-69	3.5 (89)	21.8 (6.6)	185 (84)	2310 (10275)	3 kW	1-5/8" EIA	12 kW	3-1/8" EIA
16 Bay								
14-24	3.5 (89)	40.8 (12.4)	270 (122)	3530 (15700)	4 kW	1-5/8" EIA	16 kW	3-1/8" EIA
25-30	3.5 (89)	38.8 (11.8)	265 (120)	3450 (15345)	4 kW	1-5/8" EIA	16 kW	3-1/8" EIA
31-37	3.5 (89)	36.8 (11.2)	260 (118)	3370 (14990)	4 kW	1-5/8" EIA	16 kW	3-1/8" EIA
38-45	3.5 (89)	34.8 (10.6)	255 (116)	3300 (14680)	4 kW	1-5/8" EIA	16 kW	3-1/8" EIA
46-53	3.5 (89)	32.8 (10.0)	250 (113)	3220 (14325)	4 kW	1-5/8" EIA	16 kW	3-1/8" EIA
54-61	3.5 (89)	30.8 (9.4)	245 (111)	3140 (13970)	4 kW	1-5/8" EIA	16 kW	3-1/8" EIA
62-69	3.5 (89)	28.8 (8.8)	240 (109)	3060 (13610)	4 kW	1-5/8" EIA	16 kW	3-1/8" EIA
24 Bay								
14-24	3.5 (89)	60.8 (18.5)	390 (177)	5270 (23440)	6 kW	1-5/8" EIA	24 kW	3-1/8" EIA
25-30	3.5 (89)	57.8 (17.6)	380 (172)	5150 (22910)	6 kW	1-5/8" EIA	24 kW	3-1/8" EIA
31-37	3.5 (89)	54.8 (16.7)	370 (168)	5030 (22375)	6 kW	1-5/8" EIA	24 kW	3-1/8" EIA
38-45	3.5 (89)	51.8 (15.8)	360 (163)	4910 (21840)	6 kW	1-5/8" EIA	24 kW	3-1/8" EIA
46-53	3.5 (89)	48.8 (14.9)	350 (159)	4790 (21310)	6 kW	1-5/8" EIA	24 kW	3-1/8" EIA
54-61	3.5 (89)	45.8 (14.0)	340 (154)	4670 (20775)	6 kW	1-5/8" EIA	24 kW	3-1/8" EIA
62-69	3.5 (89)	42.8 (13.0)	330 (150)	4550 (20240)	6 kW	1-5/8" EIA	24 kW	3-1/8" EIA
32 Bay								
14-24	3.5 (89)	80.8 (24.6)	490 (222)	6990 (31095)	8 kW	1-5/8" EIA	28 kW	3-1/8" EIA
25-30	3.5 (89)	76.8 (23.4)	480 (218)	6830 (30380)	8 kW	1-5/8" EIA	28 kW	3-1/8" EIA
31-37	3.5 (89)	72.8 (22.2)	470 (213)	6670 (29670)	8 kW	1-5/8" EIA	28 kW	3-1/8" EIA
38-45	3.5 (89)	68.8 (21.0)	460 (209)	6510 (28960)	8 kW	1-5/8" EIA	28 kW	3-1/8" EIA
46-53	3.5 (89)	64.8 (19.8)	450 (204)	6350 (28245)	8 kW	1-5/8" EIA	28 kW	3-1/8" EIA
54-61	3.5 (89)	60.8 (18.5)	440 (200)	6190 (27535)	8 kW	1-5/8" EIA	28 kW	3-1/8" EIA
62-69	3.5 (89)	56.8 (17.3)	430 (195)	6040 (26870)	8 kW	1-5/8" EIA	28 kW	3-1/8" EIA

Notes: † Loads are typical for 50 lb/ft² (2.4 kPa) for flat surfaces and 33 lb/ft² (1.6 kPa) for cylindrical surfaces.

** For average power rating, multiply (peak power x 0.7)



ALP Series II Antennas System Planning Worksheet

Use this worksheet to plan your material list for an efficient, cost-effective ALP antenna and HELIAX® coaxial cable system. Duplicate this page or call **Broadcast Systems at 1-800-DIAL-4-RF** for additional copies of the worksheet.

Broadcast Antenna Systems

Item No.	Description	Type No.	Qty.	Unit Price	Extended Price
Antenna and Accessories					
1	Antenna				
	Other				
Transmission Line System					
2	HELIAX Coaxial Cable				
3	HELIAX Connector, Top				
4	HELIAX Connector, Bottom				
5	Hanger Kit of 10				
	Hardware Kit of 10				
	Adaptor Kit of 10				
	Threaded Rod Support				
6	Grounding Kit				
7	Wall/Roof Feed-Thru				
8	Miter Elbow				
9	Hoisting Grip				
Pressurization Equipment					
10	Dehydrator (if required)				
11					
Total Antenna System Estimate					

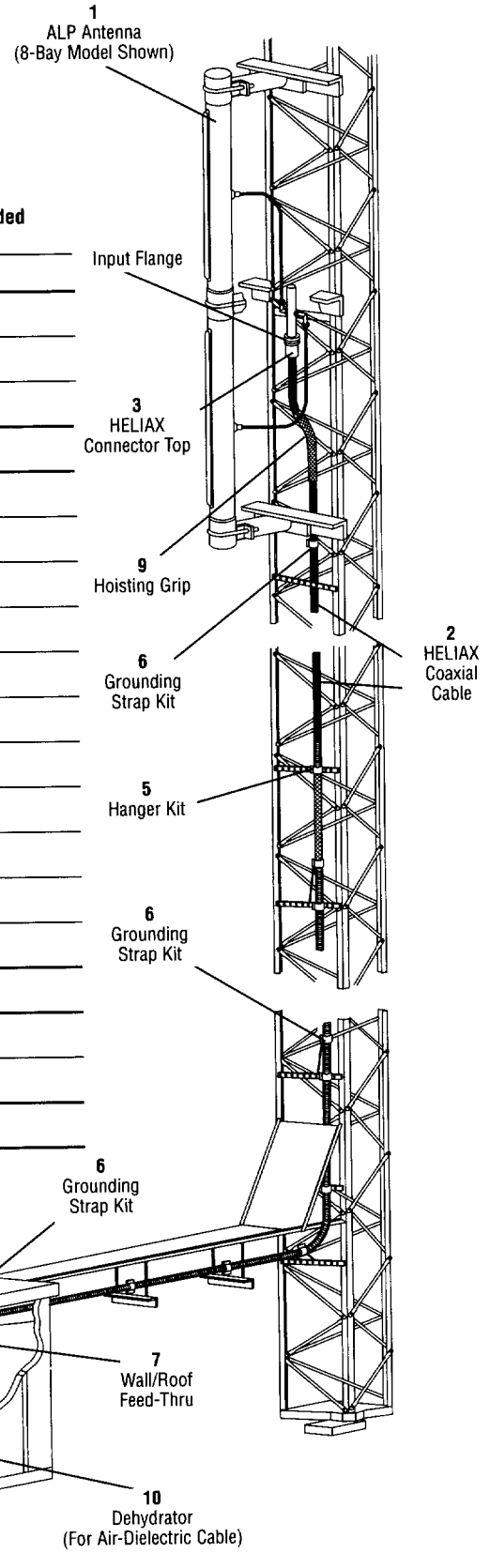

Channel(s) _____
 Location _____
 Owner _____
 Prepared By _____
 Date _____
 Telephone _____
 Notes _____

